

*Changes for the Better*

**Models PWFY-P100VM-E-BU  
PWFY-P100VM-E-AU  
PWFY-P200VM-E-AU**

## **DATA BOOK**

# Safety Precautions

- Before installing the unit, thoroughly read the following safety precautions.
- Observe these safety precautions for your safety.

## **WARNING**

This symbol is intended to alert the user to the presence of important instructions that must be followed to avoid the risk of serious injury or death.

## **CAUTION**

This symbol is intended to alert the user to the presence of important instructions that must be followed to avoid the risk of serious injury or damage to the unit.

- After reading this manual, give it to the user to retain for future reference.
- Keep this manual for easy reference. When the unit is moved or repaired, give this manual to those who provide these services.  
When the user changes, make sure that the new user receives this manual.

## **WARNING**

- **Do not use steel pipes as water pipes.**
  - Copper pipes are recommended.
- **The water circuit should be a closed circuit.**
- **Ask the dealer or an authorized technician to install the air conditioner.**
  - Improper installation by the user may result in water leakage, electric shock, or fire.
- **Install the unit in a place that can withstand its weight.**
  - Inadequate strength may cause the unit to fall down, resulting in injuries.
- **Do not touch the unit. The unit surface can be hot.**
- **Do not install the unit where corrosive gas is generated.**
- **Use the specified cables for wiring. Make the connections securely so that the outside force of the cable is not applied to the terminals.**
  - Inadequate connection and fastening may generate heat and cause a fire.
- **Prepare for rain and other moisture and earthquakes and install the unit at the specified place.**
  - Improper installation may cause the unit to topple and result in injury.
- **Always use an strainer and other accessories specified by Mitsubishi Electric.**
  - Ask an authorized technician to install the accessories. Improper installation by the user may result in water leakage, electric shock, or fire.
- **Never repair the unit. If the air conditioner must be repaired, consult the dealer.**
  - If the unit is repaired improperly, water leakage, electric shock, or fire may result.
- **Do not touch the refrigerant pipes and Water pipes.**
  - Improper handling may result in injury.
- **When handling this product, always wear protective equipment.**

**EG: Gloves, full arm protection namely boiler suit, and safety glasses.**

  - Improper handling may result in injury.
- **If refrigerant gas leaks during installation work, ventilate the room.**
  - If the refrigerant gas comes into contact with a flame, poisonous gases will be released.
- **Install the unit according to this Installation Manual.**
  - If the unit is installed improperly, water leakage, electric shock, or fire may result.
- **Have all electric work done by a licensed electrician according to “Electric Facility Engineering Standard” and “Interior Wire Regulations” and the instructions given in this manual and always use a special circuit.**
  - If the power source capacity is inadequate or electric work is performed improperly, electric shock and fire may result.
- **Keep the electric parts away from water (washing water etc.).**
  - It might result in electric shock, catching fire or smoke.
- **Securely install the heat source unit terminal cover (panel).**
  - If the terminal cover (panel) is not installed properly, dust or water may enter the heat source unit and fire or electric shock may result.
- **When installing and moving the air conditioner to another site, do not charge it with a refrigerant different from the refrigerant (R410A) specified on the unit.**
  - If a different refrigerant or air is mixed with the original refrigerant, the refrigerant cycle may malfunction and the unit may be damaged.
- **If the air conditioner is installed in a small room, measures must be taken to prevent the refrigerant concentration from exceeding the safety limit even if the refrigerant should leak.**
  - Consult the dealer regarding the appropriate measures to prevent the safety limit from being exceeded. Should the refrigerant leak and cause the safety limit to be exceeded, hazards due to lack of oxygen in the room could result.
- **When moving and reinstalling the air conditioner, consult the dealer or an authorized technician.**
  - If the air conditioner is installed improperly, water leakage, electric shock, or fire may result.

- **After completing installation work, make sure that refrigerant gas is not leaking.**
- If the refrigerant gas leaks and is exposed to a fan heater, stove, oven, or other heat source, it may generate noxious gases.
- **Do not reconstruct or change the settings of the protection devices.**
- If the pressure switch, thermal switch, or other protection device is shorted and operated forcibly, or parts other than those specified by Mitsubishi Electric are used, fire or explosion may result.
- **To dispose of this product, consult your dealer.**
- **The installer and system specialist shall secure safety against leakage according to local regulation or standards.**
- Following standards may be applicable if local regulation are not available.
- **Pay a special attention to the place, such as a basement, etc. where refrigeration gas can stay, since refrigeration is heavier than the air.**

## Precautions for handling units for use with R410A

### CAUTION

- **Do not use the existing refrigerant piping.**
- The old refrigerant and refrigerant oil in the existing piping contains a large amount of chlorine which may cause the refrigerant oil of the new unit to deteriorate.
- R410A is a high-pressure refrigerant and can cause the existing piping to burst.
- **Use refrigerant piping made of C1220 (CU-DHP) phosphorus deoxidized copper as specified in the JIS H3300 “Copper and copper alloy seamless pipes and tubes”. In addition, be sure that the inner and outer surfaces of the pipes are clean and free of hazardous sulphur, oxides, dust/dirt, shaving particles, oils, moisture, or any other contaminant.**
- Contaminants on the inside of the refrigerant piping may cause the refrigerant residual oil to deteriorate.
- **Store the piping to be used during installation indoors and keep both ends of the piping sealed until just before brazing. (Store elbows and other joints in a plastic bag.)**
- If dust, dirt, or water enters the refrigerant cycle, deterioration of the oil and compressor trouble may result.
- **Use ester oil, ether oil or alkylbenzene (small amount) as the refrigerant oil to coat flares and flange connections.**
- The refrigerant oil will degrade if it is mixed with a large amount of mineral oil.
- **Use liquid refrigerant to fill the system.**
- If gas refrigerant is used to seal the system, the composition of the refrigerant in the cylinder will change and performance may drop.
- **Do not use a refrigerant other than R410A.**
- If another refrigerant (R22, etc.) is mixed with R410A, the chlorine in the refrigerant may cause the refrigerant oil to deteriorate.
- **Use a vacuum pump with a reverse flow check valve.**
- The vacuum pump oil may flow back into the refrigerant cycle and cause the refrigerant oil to deteriorate.
- **Do not use the following tools that are used with conventional refrigerants.**  
(Gauge manifold, charge hose, gas leak detector, reverse flow check valve, refrigerant charge base, refrigerant recovery equipment)
- If the conventional refrigerant and refrigerant oil are mixed in the R410A, the refrigerant may deteriorate.
- If water is mixed in the R410A, the refrigerant oil may deteriorate.
- Since R410A does not contain any chlorine, gas leak detectors for conventional refrigerants will not react to it.
- **Do not use a charging cylinder.**
- Using a charging cylinder may cause the refrigerant to deteriorate.
- **Be especially careful when managing the tools.**
- If dust, dirt, or water gets in the refrigerant cycle, the refrigerant may deteriorate.

## Before installing the unit

 **WARNING**

- **Do not install the unit where combustible gas may leak.**
  - If the gas leaks and accumulates around the unit, an explosion may result.
- **Do not use the air conditioner where food, pets, plants, precision instruments, or artwork are kept.**
  - The quality of the food, etc. may deteriorate.
- **Do not use the air conditioner in special environments.**
  - Oil, steam, sulfuric smoke, etc. can significantly reduce the performance of the air conditioner or damage its parts.
- **When installing the unit in a hospital, communication station, or similar place, provide sufficient protection against noise.**
  - The inverter equipment, private power generator, high-frequency medical equipment, or radio communication equipment may cause the air conditioner to operate erroneously, or fail to operate. On the other hand, the air conditioner may affect such equipment by creating noise that disturbs medical treatment or image broadcasting.
- **Do not install the unit on a structure that may cause leakage.**
  - When the room humidity exceeds 80 % or when the drain pipe is clogged, condensation may drip from the indoor unit. Perform collective drainage work together with the unit, as required.

## Before installing the unit (moving and reinstalling the unit) and performing electrical work

### CAUTION

- **Ground the unit.**
  - Do not connect the ground wire to gas or water pipes, lightning rods, or telephone ground lines. Improper grounding may result in electric shock.
- **Install the power cable so that tension is not applied to the cable.**
  - Tension may cause the cable to break and generate heat and cause a fire.
- **Install a leak circuit breaker, as required.**
  - If a leak circuit breaker is not installed, electric shock may result.
- **Use power line cables of sufficient current carrying capacity and rating.**
  - Cables that are too small may leak, generate heat, and cause a fire.
- **Use only a circuit breaker and fuse of the specified capacity.**
  - A fuse or circuit breaker of a larger capacity or a steel or copper wire may result in a general unit failure or fire.
- **Do not wash the air conditioner units.**
  - Washing them may cause an electric shock.
- **Be careful that the installation base is not damaged by long use.**
  - If the damage is left uncorrected, the unit may fall and cause personal injury or property damage.
- **Install the drain piping according to this Installation Manual to ensure proper drainage. Wrap thermal insulation around the pipes to prevent condensation.**
  - Improper drain piping may cause water leakage and damage to furniture and other possessions.
- **Be very careful about product transportation.**
  - Only one person should not carry the product if it weighs more than 20 kg.
  - Some products use PP bands for packaging. Do not use any PP bands for a means of transportation. It is dangerous.
  - When transporting the unit, support it at the specified positions on the unit base. Also support the unit at four points so that it cannot slip side ways.
- **Safely dispose of the packing materials.**
  - Packing materials, such as nails and other metal or wooden parts, may cause stabs or other injuries.
  - Tear apart and throw away plastic packaging bags so that children will not play with them. If children play with a plastic bag which was not torn apart, they face the risk of suffocation.

## Before the test run

### CAUTION

- **Turn on the power at least 12 hours before starting operation.**
  - Starting operation immediately after turning on the main power switch can result in severe damage to internal parts. Keep the power switch turned on during the operational season.
- **Do not touch the switches with wet fingers.**
  - Touching a switch with wet fingers can cause electric shock.
- **Do not touch the refrigerant pipes during and immediately after operation.**
  - During and immediately after operation, the refrigerant pipes are may be hot and may be cold, depending on the condition of the refrigerant flowing through the refrigerant piping, compressor, and other refrigerant cycle parts. Your hands may suffer burns or frostbite if you touch the refrigerant pipes.
- **Do not operate the air conditioner with the panels and guards removed.**
  - Rotating, hot, or high-voltage parts can cause injuries.
- **Do not turn off the power immediately after stopping operation.**
  - Always wait at least five minutes before turning off the power. Otherwise, water leakage and trouble may occur.
- **Do not touch the surface of the compressor during servicing.**
  - If unit is connected to the supply and not running, crank case heater at compressor is operating.
- **Do not touch the panels near the fan exhaust outlet with bare hands: they can get hot while the unit is in operation (even if it is stopped) or immediately after operation and poses a risk of burns. Wear gloves to protect your hands when it is necessary to touch the panels.**
- **While the unit is in operation or immediately after operation, high-temperature exhaust air may blow out of the fan exhaust outlet. Do not hold your hands over the outlet or touch the panels near the outlet.**
- **Be sure to provide a pathway for the exhaust air from the fan.**
- **Water pipes can get very hot, depending on the preset temperature. Wrap the water pipes with insulating materials to prevent burns.**

# Contents

## Safety Precautions

### I General Equipment Descriptions

1. Unit configuration table..... 1
2. Operable temperature range ..... 1
3. Connectable outdoor unit capacity range ..... 1

### II Product Specifications

1. Specifications ..... 2
2. External Dimensions..... 5
  - (1) PWFY-P100VM-E-BU
  - (2) PWFY-P100, 200VM-E-AU
3. Electrical Wiring Diagrams ..... 7
  - (1) PWFY-P100VM-E-BU
  - (2) PWFY-P100, 200VM-E-AU
4. Accessories ..... 9

### III Product Data

1. Capacity tables ..... 10
  - (1) Correction by temperature
  - (2) Correction by water flow rate
  - (3) Correction by total indoor
  - (4) Correction by refrigerant piping length
  - (5) Correction at frosting and defrosting
  - (6) Water pressure drop
  - (7) Temperature range of running
2. Sound levels ..... 27
  - (1) PWFY-P100VM-E-BU
  - (2) PWFY-P100, 200VM-E-AU
3. Vibration levels ..... 28
  - (1) PWFY-P100VM-E-BU
4. Refrigerant circuit diagrams and thermal sensors ..... 29
  - (1) PWFY-P100VM-E-BU
  - (2) PWFY-P100VM-E-AU
  - (3) PWFY-P200VM-E-AU

### IV Installation

1. How to calculate the necessary heat capacity..... 30
  - (1) Heating capacity calculation
  - (2) A calculation example
2. Installation ..... 31
  - (1) Selecting an installation site
  - (2) Installing the unit
  - (3) Refrigerant pipe and drain pipe specifications
  - (4) Connecting refrigerant pipes and drain pipes

3. Water pipe installation ..... 37
  - (1) Water circuit sample
  - (2) Selecting a water pump
  - (3) Installing the strainer
  - (4) Precautions during installation
  - (5) Example of unit installation (using light piping)
  - (6) Insulation installation
  - (7) Water processing and water quality control
  - (8) Pump interlock

### V System Design

1. Electrical work ..... 42
  - (1) General cautions
  - (2) Power supply for PWFY unit
  - (3) Connecting remote controller, indoor and outdoor transmission cables
  - (4) Transmission cable specifications
  - (5) Connecting electrical connections
  - (6) Address setting
  - (7) External input/output function

### VI Control

1. Dip switch functions..... 50
2. Remote controller specifications..... 51

### VII Maintenance Cycle

1. Routine maintenance checks ..... 52
2. Parts Replacement Cycle..... 52

### VIII Product Data (supplemental information for chapter III.)

1. Capacity tables ..... 53
  - (1) Correction by total indoor
  - (2) Correction by refrigerant piping length
  - (3) Correction at frosting and defrosting

# I General Equipment Descriptions

## 1. Unit configuration table

Model	PWFY-P100VM-E-BU	PWFY-P100VM-E-AU	PWFY-P200VM-E-AU
Outdoor unit	PURY-(E)P*Y(S)HM-A(-BS)	PUHY-(E)P* Y(S)HM-A(-BS)	
		PURY-(E)P* Y(S)HM-A(-BS)	

## 2. Operable temperature range

<PWFY-P100VM-E-BU>

		Only PWFY	PWFY with standard indoor unit	Only standard indoor units	(WB)
		Heating			
Inlet water temperature	R2 series	10 to 70°C	10 to 70°C	-	
Outdoor temperature	R2 series	-20 to 32°C	-20 to 32°C	-20 to 15.5°C	

<PWFY-P100, P200VM-E-AU>

		Only PWFY		PWFY with standard indoor units		(WB)
		Cooling	Heating	Cooling	Heating	
Inlet water temperature	R2 series	10 to 35°C	10 to 40°C	10 to 35°C	10 to 40°C	
	Y series	10 to 35°C	10 to 40°C	10 to 35°C	10 to 40°C	
Outdoor temperature	R2 series	-5 to 43°C	-20 to 32°C	-5 to 43°C	-20 to 32°C	
	Y series	-5 to 43°C	-20 to 15.5°C	-5 to 43°C	-20 to 15.5°C	

		Only standard indoor units		(WB)
		Cooling	Heating	
Inlet water temperature	R2 series	-	-	
	Y series	-	-	
Outdoor temperature	R2 series	-5 to 43°C	-20 to 15.5°C	
	Y series	-5 to 43°C	-20 to 15.5°C	

Outdoor unit will change its software to PWFY connection version automatically when PWFY is connected.  
R2 series allow higher temperature range than Y series, the reason is that R2 has an effective heat exchanger bypass circuit against Hi-cut.

## 3. Connectable outdoor unit capacity range

<PWFY-P100VM-E-BU>

	Only PWFY	PWFY with standard indoor units	Only standard indoor units
R2 series	50 to 100%	50 to 150%	50 to 150%

<PWFY-P100, P200VM-E-AU>

	Only PWFY	PWFY with standard indoor units	Only standard indoor units
R2 series	50 to 100%	50 to 150%	50 to 150%
Y series	50 to 100%	50 to 130%	50 to 130%



# II Product Specifications

## 1. Specifications

Model		PWFY-P100VM-E-BU	
Power source		1-phase 220-230-240V 50/60Hz	
Heating capacity (Nominal )		kW	12.5
		kcal / h	10,800
		Btu / h	42,700
	Power input	kW	2.48
	Current input	A	11.63 - 11.12 - 10.66
Temp. range of heating	Outdoor temp.	W.B	-20~32°C (59~90°F)
	Inlet Water temp.	-	10~70°C (50~158°F)
Connectable outdoor unit	Total capacity	50~100% of outdoor unit capacity	
	Model / Quantity	PURY-P200YHM-A(-BS)-PURY-P400YHM-A(-BS) PURY-P450YSHM-A(-BS)-PURY-P800YSHM-A(-BS) PURY-EP200YHM-A(-BS)-PURY-EP300YHM-A(-BS) PURY-EP400YSHM-A(-BS)-PURY-EP600YSHM-A(-BS)	
Noise level (measured in anechoic room)		dB<A>	44
Diameter of refrigerant pipe	Liquid	mm(in.)	9.52 ( 3/8") Brazed
	Gas	mm(in.)	15.88 ( 5/8") Brazed
Diameter of water pipe	Inlet	mm(in.)	PT3/4 Screw
	Outlet	mm(in.)	PT3/4 Screw
Field drain pipe size		mm(in.)	32 (1-1/4")
External finish		NO	
External dimension H x W x D		mm	800 (785 without legs) x 450 x 300
		in.	31-1/2" (30-15/16" without legs) x 17-3/4" x 11-13/16"
Net weight		kg(lb)	60 (133)
Compressor	Type	Inverter rotary hermetic compressor	
	Maker	MITSUBISHI ELECTRIC CORPORATION	
	Starting method	Inverter	
	Motor output	kW	1.0
	Lubricant	NEO22	
Circulating water	Operation volume	m³/h	0.6~2.15
	Range		
Protection on Internal circuit (R134a)	High pressure protection	High pressure sensor, High pressure switch at 3.60 MPa (601 psi)	
	Inverter circuit (COMP)	Over-heat protection, Over-current protection	
	Compressor	Discharge thermo protection, Over-current protection	
Refrigerant	Type x original charge	R134a x 1.1kg (0.50lb)	
	Control	LEV	
Design pressure	R410a	MPa	4.15
	R134a	MPa	3.60
	Water	MPa	1.00
Drawing	External	WKB94L762	
	Wiring	E64C226X01	
Standard attachment	Document	Installation Manual, Instruction Book	
	Accessory	Strainer, Heat insulation material, 2 x Connector sets	
Optional parts		NONE	
Remark		Details on foundation work, duct work, insulation work, electrical wiring, power source switch, and other items shall be referred to the Installation Manual.	
Note:		Unit converter	
*1 Nominal heating conditions Outdoor Temp. : 7°CDB/6°CWB (45°FDB / 43°FWB) Pipe length : 7.5 m (24-9/16 ft) Level difference : 0m (0ft) Inlet water Temp 65°C Water flow rate 2.15m³/h		kcal = kW x 860 Btu/h = kW x 3,412 cfm = m³/min x 35.31 lb = kg / 0.4536	
* Due to continuing improvement, the above specifications may be subject to change without notice. * The unit is not designed for outside installations. * Please don't use the steel material for the water piping material. * Please always make water circulate or add the brine to the circulation water when the ambient temperature becomes 0°C or less. * Please always make water circulate or pull out the circulation water completely when not using it. * Please do not use groundwater and well water.		* Install the unit in an environment where the wet bulb Temp. will not exceed 32degC. * The water circuit must use the closed circuit. * Please do not use it as a drinking water.	
		* The specification data is subject to rounding variation.	

Model			PWFY-P100VM-E-AU
Power source			1-phase 220-230-240V 50/60Hz
Heating capacity (Nominal)	*1	kW	12.5
	*1	kcal / h	10,800
	*1	Btu / h	42,700
	Power input		kW
Current input		A	0.068 - 0.065 - 0.063
Temp. range of heating	Outdoor temp.		-20~32°C (-4~90°F) PURY - series
	W.B		-20~15.5°C (-4~60°F) PUHY - series
	Inlet Water temp.		-
			10~40°C (50~104°F)
Cooling capacity (Nominal)	*2	kW	11.2
	*2	kcal / h	9,600
	*2	Btu / h	38,200
	Power input		kW
Current input		A	0.068 - 0.065 - 0.063
Temp. range of cooling	Outdoor temp.		-5~43°C (23~110°F) PURY - series
	D.B		-5~43°C (23~110°F) PUHY - series
	Inlet Water temp.		-
			10~35°C (50~95°F)
Connectable outdoor unit	Total capacity		50~100% of outdoor unit capacity
	Model / Quantity		PURY-P200YHM-A(-BS)-PURY-P400YHM-A(-BS) PURY-P450YSHM-A(-BS)-PURY-P800YSHM-A(-BS) PURY-EP200YHM-A(-BS)-PURY-EP300YHM-A(-BS) PURY-EP400YSHM-A(-BS)-PURY-EP600YSHM-A(-BS) PUHY-P200YHM-A(-BS)-PUHY-P450YHM-A(-BS) PUHY-P500YSHM-A(-BS)-PUHY-P1250YSHM-A(-BS) PUHY-EP200YHM-A(-BS)-PUHY-EP300YHM-A(-BS) PUHY-EP400YSHM-A(-BS)-PUHY-EP900YSHM-A(-BS)
Noise level (measured in anechoic room)			dB<A> 29
Diameter of refrigerant pipe	Liquid	mm(in.)	9.52 ( 3/8") Brazed
	Gas	mm(in.)	15.88 ( 5/8") Brazed
Diameter of water pipe	Inlet	mm(in.)	PT3/4 Screw
	Outlet	mm(in.)	PT3/4 Screw
Field drain pipe size			mm(in.) 32 (1-1/4")

External finish			NO
External dimension H x W x D	mm		800 (785 without legs) x 450 x 300
	in.		31-1/2" (30-15/16" without legs) x 17-3/4" x 11-13/16"
Net weight			kg(lb) 35 (78)
Circulating water	Operation Volume Range		m³/h 0.6~2.15
	R410a	MPa	4.15
Design pressure	Water		MPa 1.00
	External		WKB94L763
Drawing	Wiring		E00C223
	Document		Installation Manual, Instruction Book
Standard attachment		Accessory	Strainer, Heat insulation material, 2 x Connector sets
Optional parts			NONE
Remark			Details on foundation work, duct work, insulation work, electrical wiring, power source switch, and other items shall be referred to the Installation Manual.

Note:	*1 Nominal heating conditions	*2 Nominal cooling conditions	Unit converter
	Outdoor Temp. : 7°CDB/6°CWB (45°FDB / 43°FWB) Pipe length : 7.5 m (24-9/16 ft) Level difference : 0m (0ft) Inlet water Temp 30°C    Water flow rate 2.15m³/h	Outdoor Temp. : 35°CDB (95°FDB) Pipe length : 7.5 m (24-9/16 ft) Level difference : 0m (0ft) Inlet water Temp 23°C    Water flow rate 1.93m³/h	
* Due to continuing improvement, the above specifications may be subject to change without notice.		* Install the unit in an environment where the wet bulb Temp. will not exceed 32degC.	
* The unit is not designed for outside installations.		* Please don't use the steel material for the water piping material.    * The water circuit must use the closed circuit.	
* Please don't use the steel material for the water piping material.		* Please always make water circulate or add the brine to the circulation water when the ambient temperature becomes 0°C or less.	
* Please always make water circulate or pull out the circulation water completely when not using it.		* Please do not use it as a drinking water.	
* Please do not use groundwater and well water.			

Model			PWFY-P200VM-E-AU	
Power source			1-phase 220-230-240V 50/60Hz	
Heating capacity (Nominal)	*1	kW	25.0	
	*1	kcal / h	21,500	
	*1	Btu / h	85,300	
	Power input		kW	0.015
	Current input		A	0.068 - 0.065 - 0.063
Temp. range of heating	Outdoor temp.		-20~32°C (-4~90°F) PURY - series	
			-20~15.5°C (-4~60°F) PUHY - series	
	Inlet Water temp.		- 10~40°C (50~104°F)	
Cooling capacity (Nominal)	*2	kW	22.4	
	*2	kcal / h	19,300	
	*2	Btu / h	76,400	
	Power input		kW	0.015
	Current input		A	0.068 - 0.065 - 0.063
Temp. range of cooling	Outdoor temp.		-5~43°C (23~110°F) PURY - series	
			-5~43°C (23~110°F) PUHY - series	
	Inlet Water temp.		- 10~35°C (50~95°F)	
Connectable outdoor unit	Total capacity		50~100% of outdoor unit capacity	
	Model / Quantity		PURY-P200YHM-A(-BS)-PURY-P400YHM-A(-BS) PURY-P450YSHM-A(-BS)-PURY-P800YSHM-A(-BS) PURY-EP200YHM-A(-BS)-PURY-EP300YHM-A(-BS) PURY-EP400YSHM-A(-BS)-PURY-EP600YSHM-A(-BS) PUHY-P200YHM-A(-BS)-PUHY-P450YHM-A(-BS) PUHY-P500YSHM-A(-BS)-PUHY-P1250YSHM-A(-BS) PUHY-EP200YHM-A(-BS)-PUHY-EP300YHM-A(-BS) PUHY-EP400YSHM-A(-BS)-PUHY-EP900YSHM-A(-BS)	
Noise level (measured in anechoic room)			dB<A> 29	
Diameter of refrigerant pipe	Liquid	mm(in.)	9.52 ( 3/8") Brazed	
	Gas	mm(in.)	19.05 ( 3/4") Brazed	
Diameter of water pipe	Inlet	mm(in.)	PT 1 Screw	
	Outlet	mm(in.)	PT 1 Screw	
Field drain pipe size			mm(in.) 32 (1-1/4")	

External finish			NO
External dimension H x W x D	mm		800 (785 without legs) x 450 x 300
	in.		31-1/2" (30-15/16" without legs) x 17-3/4" x 11-13/16"
Net weight			kg(lb) 38 (84)
Circulating water	Operation Volume Range		m³/h 1.2~4.30
	R410a	MPa	4.15
Design pressure	Water		MPa 1.00
	External		WKB94L763
Drawing	Wiring		E94C228X01
	Document		Installation Manual, Instruction Book
Standard attachment			Accessory Strainer, Connector, Heat insulation material, 2 x Connector sets, Expansion joint
Optional parts			NONE
Remark			Details on foundation work, duct work, insulation work, electrical wiring, power source switch, and other items shall be referred to the Installation Manual.

Note:	*1 Nominal heating conditions	*2 Nominal cooling conditions	Unit converter
	Outdoor Temp. : 7°CDB/6°CWB (45°FDB / 43°FWB) Pipe length : 7.5 m (24-9/16 ft) Level difference : 0m (0ft) Inlet water Temp 30°C    Water flow rate 4.30m³/h	Outdoor Temp. : 35°CDB (95°FDB) Pipe length : 7.5 m (24-9/16 ft) Level difference : 0m (0ft) Inlet water Temp 23°C    Water flow rate 3.86m³/h	
* Due to continuing improvement, the above specifications may be subject to change without notice.		* Install the unit in an environment where the wet bulb Temp. will not exceed 32degC.	
* The unit is not designed for outside installations.		* The water circuit must use the closed circuit.	
* Please don't use the steel material for the water piping material.		* Please always make water circulate or add the brine to the circulation water when the ambient temperature becomes 0°C or less.	
* Please always make water circulate or pull out the circulation water completely when not using it.		* Please do not use it as a drinking water.	
* Please do not use groundwater and well water.			

## 2. External Dimensions

### (1) PWFY-P100VM-E-BU

- <Accessories>
- Y-type strainer (RC3/4) ..... 1pc.
  - Heat Insulation material ..... 1pc.
  - Connector set ..... 2set
- Note 1. Ensure no rain water or debris can enter the unit through any gaps around wiring or piping.
2. Ensure adequate service space is right around the unit, according to Fig A.
  3. Please always make water circulate or add the brine to the circulation water when the ambient temperature becomes 0°C or less.
  4. The unit is not designed for outside installations.
  5. Install the unit in an environment where the wet bulb Temp. will not exceed 32degC.
  6. Please always make water circulate or pull out the circulation water completely when not using it.
  7. The water circuit must use the closed circuit.
  8. Please don't use the steel material for the water piping material.
  9. Connect the strainer which is put as accessory to water inlet pipe.

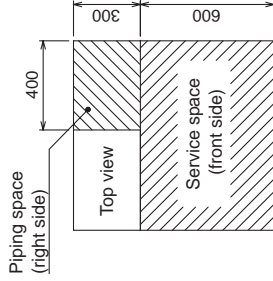
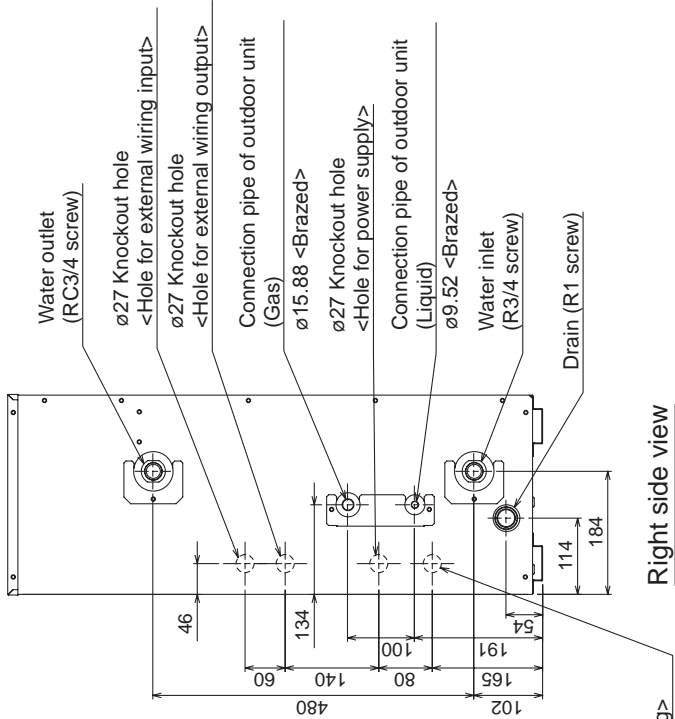
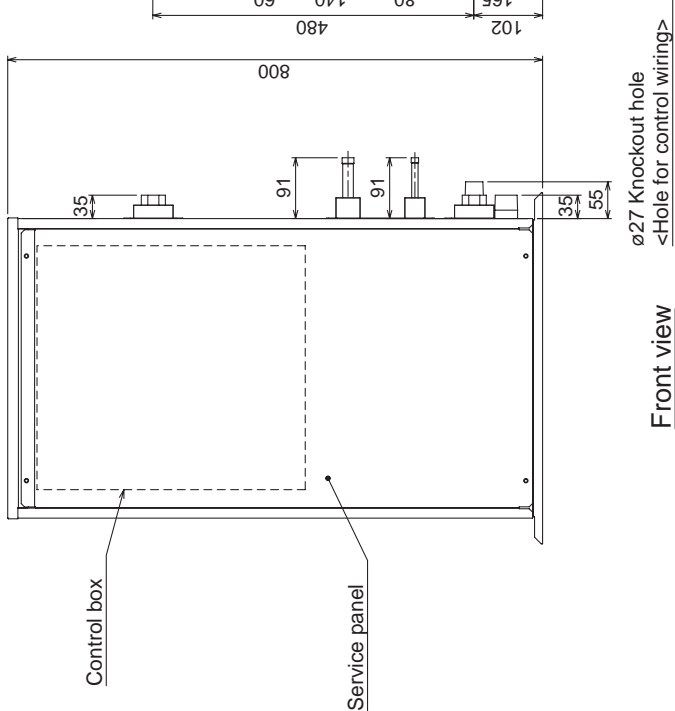
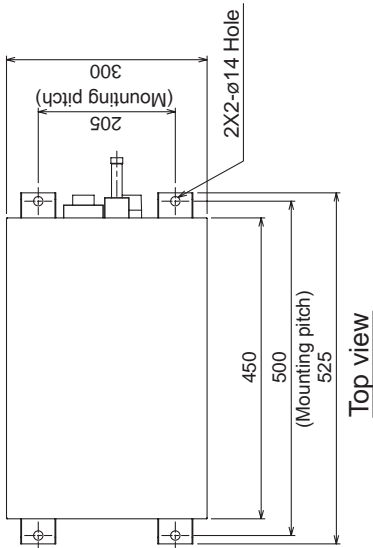

<Unit:mm>

(2) PWFY-P100, 200VM-E-AU

- <Accessories>
- Y-type strainer (RC3/4) ..... 1pc.
  - Heat Insulation material ..... 1pc.
  - Connector set ..... 2set
  - Expansion joint (P200) ..... 2pc.
- [From RC3/4 to RC1]

- Note 1. Ensure no rain water or debris can enter the unit through any gaps around wiring or piping.
2. Ensure adequate service space is right around the unit, according to Fig A.
3. Please always make water circulate or add the brine to the circulation water when the ambient temperature becomes 0°C or less.
4. The unit is not designed for outside installations.
5. Install the unit in an environment where the wet bulb Temp. will not exceed 32degC.
6. Please always make water circulate or pull out the circulation water completely when not using it.
7. The water circuit must use the closed circuit.
8. Please don't use the steel material for the water piping material.
9. Connect the strainer which is put as accessory to water inlet pipe.

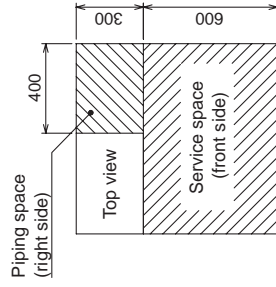
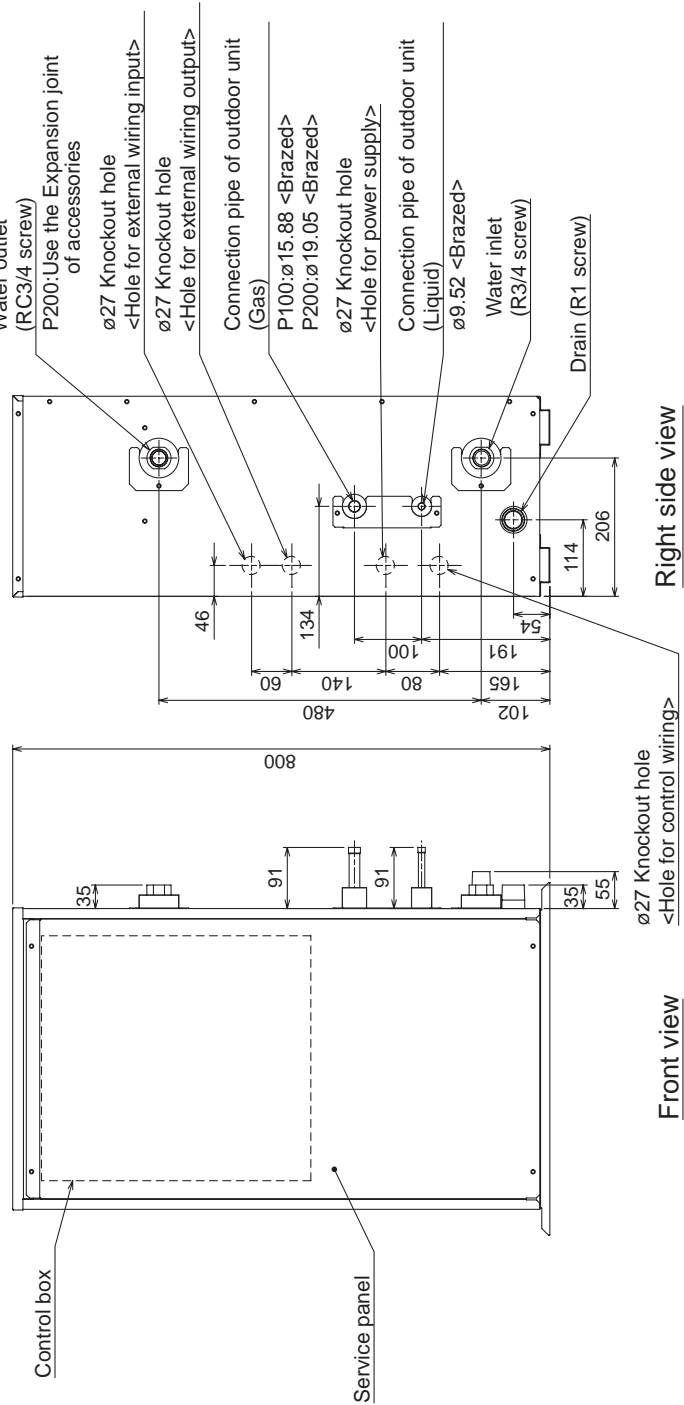
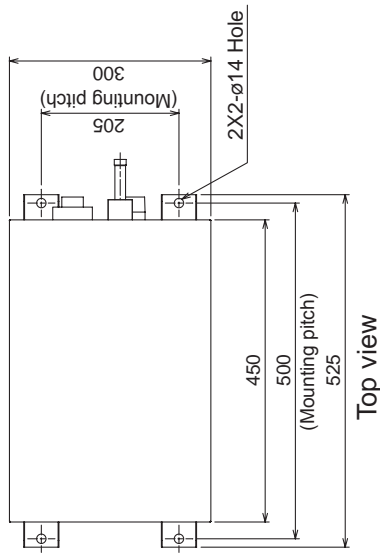

<Unit:mm>

### 3. Electrical Wiring Diagrams

#### (1) PWFY-P100VM-E-BU

- <HIGH VOLTAGE WARNING>  
 Control box houses high-voltage parts.  
 Before inspecting the inside of the control box, turn off the power, keep the unit off for at least 10 minutes, and confirm that the voltage CAG31 on Control Board has dropped to DC220V or less.  
 <CAUTION FOR INSTALLATION>  
 •Prior to installation, read the Installation Manual carefully.  
 \*1. Single-dotted lines indicate wiring not supplied with the unit.  
 \*2. Dot-dash lines indicate the control box boundaries.  
 \*3. Faston terminals have a locking function.  
 Make sure the terminals are securely locked in place after insertion.  
 Press the tab on the terminals to removed them.

\*4 TB141A(output)

Symbol	Function
OUT1	Operation ON/OFF
OUT2	Defrost
OUT3	Compressor
OUT4	Error signal

\*5 TB142A(input)

Symbol	Function
IN1	Pump interlock

\*6 TB142B(input)

Symbol	Function
IN3	Connection demand
IN4	Operation ON/OFF

\*7 TB142C(input)

Symbol	Function
COM+	Common
IN5	Hot water
IN6	Heating ECO
IN7	Anti-freeze

<Symbol explanation>

Symbol	Explanation
63H1	Pressure switch (High pressure protection for the booster unit)
63HS	Pressure sensor
E3LS	Discharge pressure
E2C	Magnetic relay(main circuit)
ACL	AC reactor
LEV1	Current sensor(AC)
LEV2	Expansion valve
LEV3	BC controller/outdoor unit Booster unit
LEV4	Power supply
LEV5	Outdoor unit/BC controller
LEV6	MA remote controller
TH11	Compressor discharge temp
TH13	Evaporator outlet temp
TH22	Liquid pipe temp
TH6	Water inlet temp
TH7	Water outlet temp
TH8S	ICBT temp

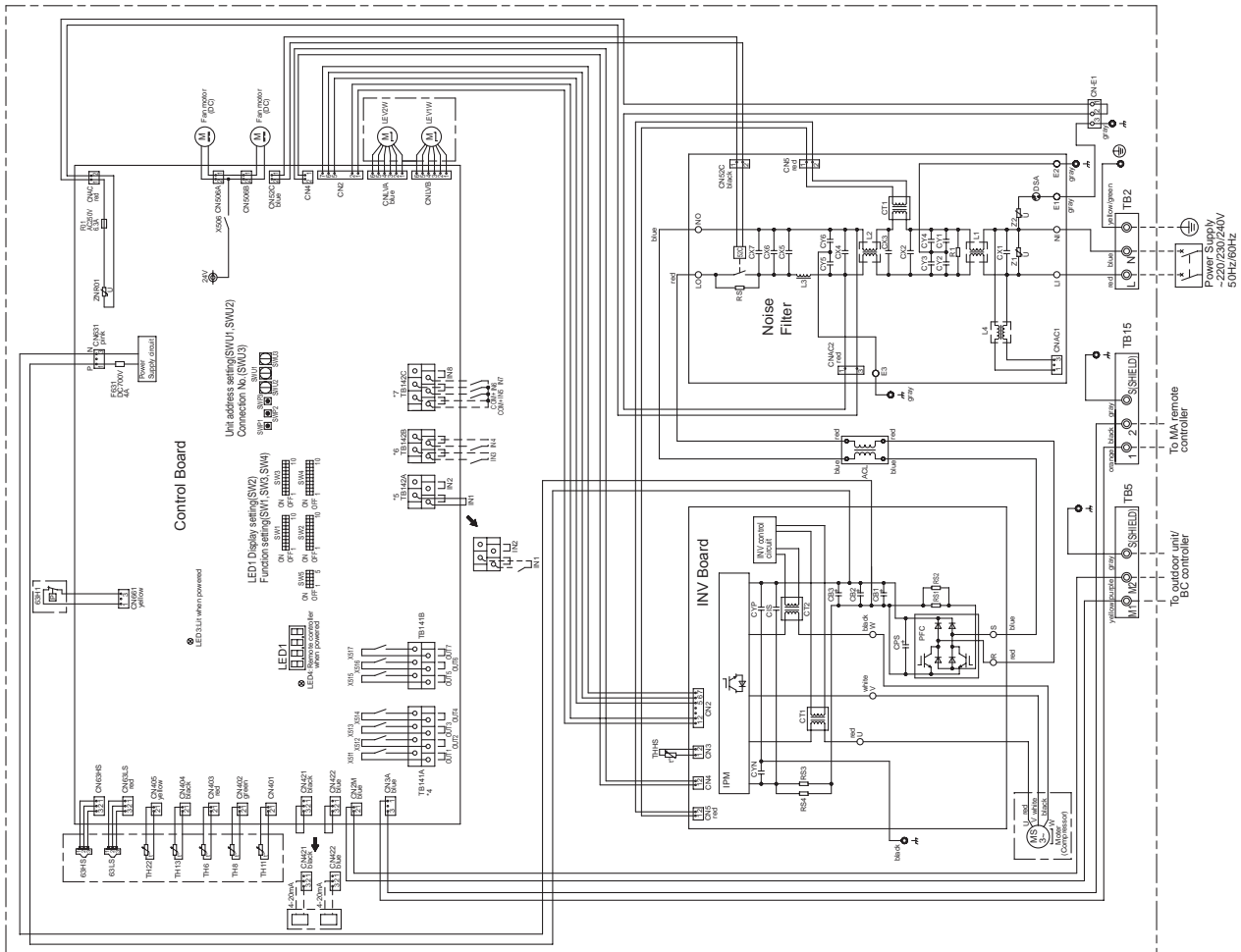

## (2) PWFY-P100, 200VM-E-AU

### <CAUTION FOR INSTALLATION>

- Prior to installation, read the Installation Manual carefully.
- 1. Single-dotted lines indicate wiring not supplied with the unit.
- 2. Dot-dash lines indicate the control box boundaries.
- 3. Difference of appliances.

Model name	Appliance
P100	*3, do not exist
P200	*3, exist

### \*4 TB141A (output)

Symbol	Function
OUT1	Operation ON/OFF
OUT2	Defrost
OUT4	Error signal

### \*5 TB142A (input)

Symbol	Function
IN1	Pump interlock

### \*6 TB142B (input)

Symbol	Function
IN3	Connection demand
IN4	Operation ON/OFF

### \*7 TB142C (input)

Symbol	Function
COM	Common
IN5	Heating
IN6	Heating ECO
IN7	Anti-freeze
IN8	Cooling

### <Symbol explanation>

Symbol	Explanation
SV1	Solenoid valve
LEV1/Wa	Linear expansion valve
LEV1/Wb	Linear expansion valve
TB2	Terminal block
TB5	Terminal block
TB15	Terminal block
TH22	Thermistor
TH2	Liquid pipe temp.
TH3	Gas pipe temp.
TH4	Indoor temp.
TH8	Water outlet temp.

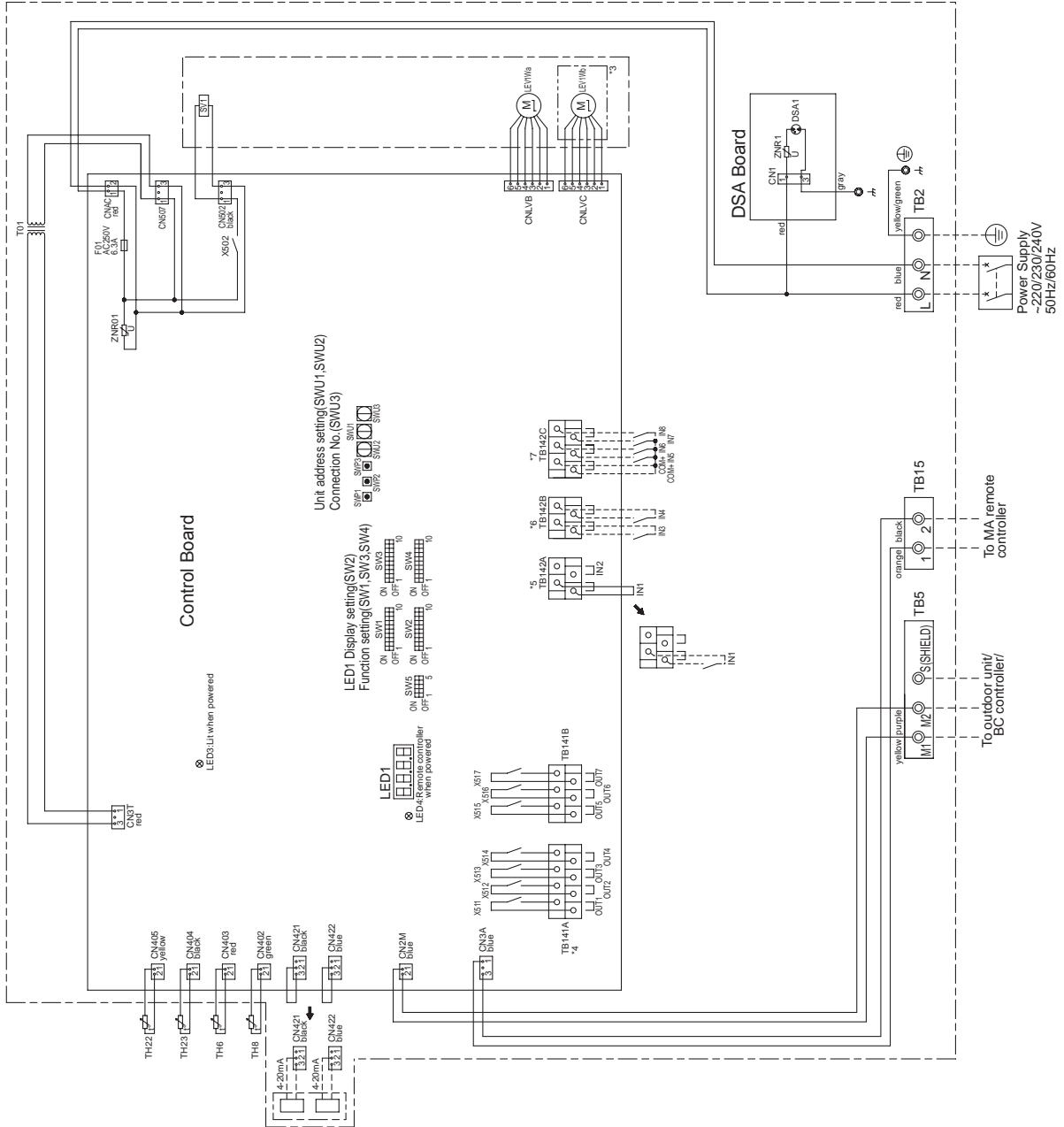

## 4. Accessories

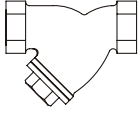
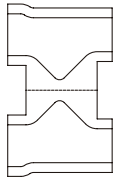
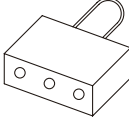
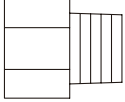
(A) Strainer	(B) Heat insulation material	(C) Connector sets × 2	(D) Expansion joint × 2
			 *1

\*1. PWFY-P200VM-E-AU only

- (A) Install the strainer at the water pipe inlet.
- (B) This insulation is for exclusive use with the strainer. Wrap the strainer with the insulation after water pipes are installed.
- (C) These are analog input connectors. Cut the wire before using.
- (D) Supplied only with the PWFY-P200VM-E-AU. Install them at the strainer inlet. Refer to P39 for details.



# III Product Data

## 1. Capacity tables

(1) Correction by temperature

(1)-1 PWFY-P100VM-E-BU

PURY-	P200,250YHM-A	EP200YHM-A
-------	---------------	------------

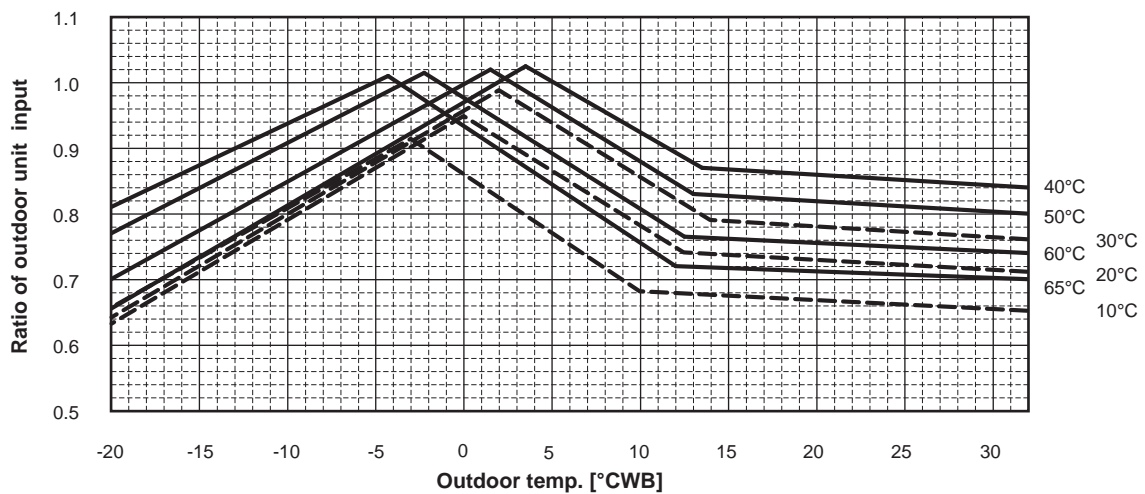
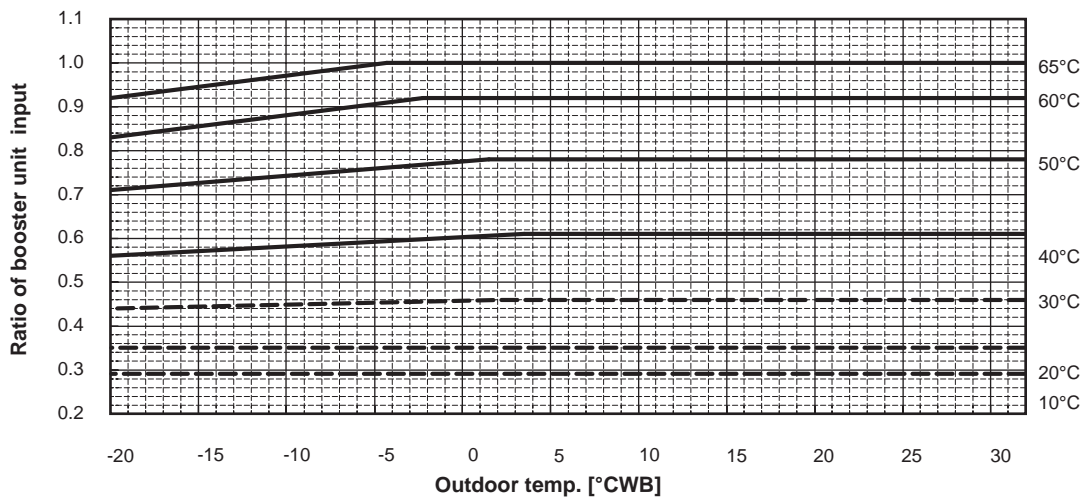
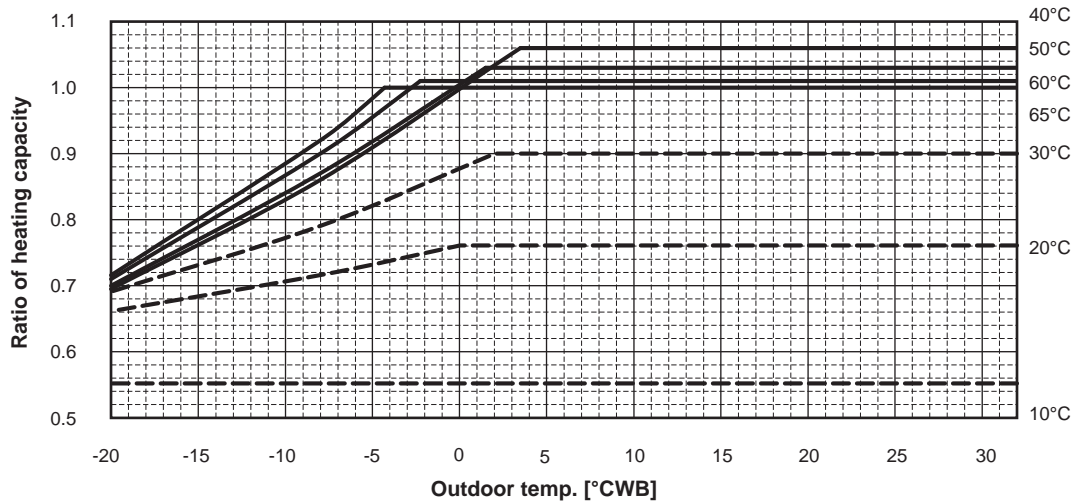

PURY-	P300,350,400YHM-A	EP300,400YHM-A
-------	-------------------	----------------

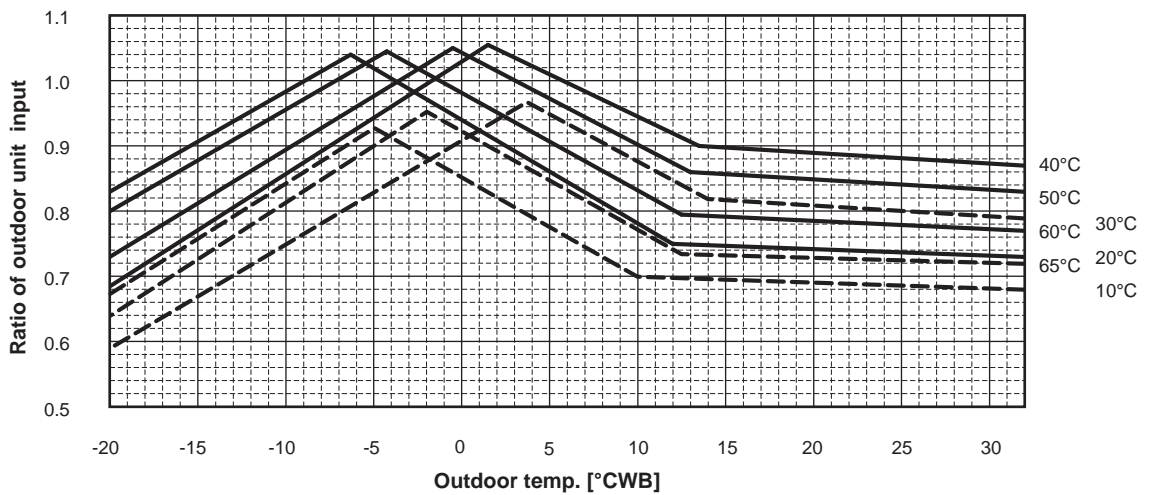
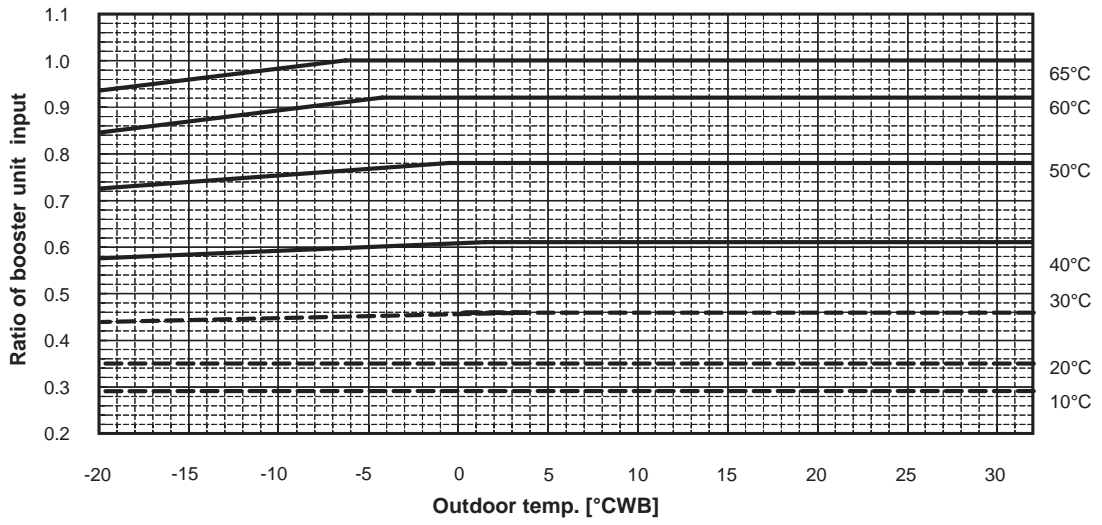
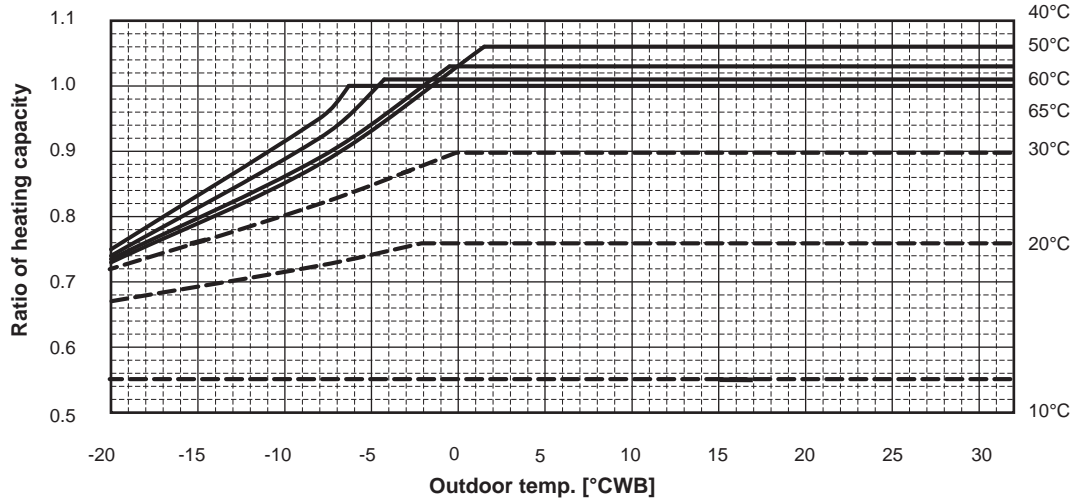

PURY-	P450,500,550,600,650YHM-A	EP450,500,550,600YHM-A
-------	---------------------------	------------------------

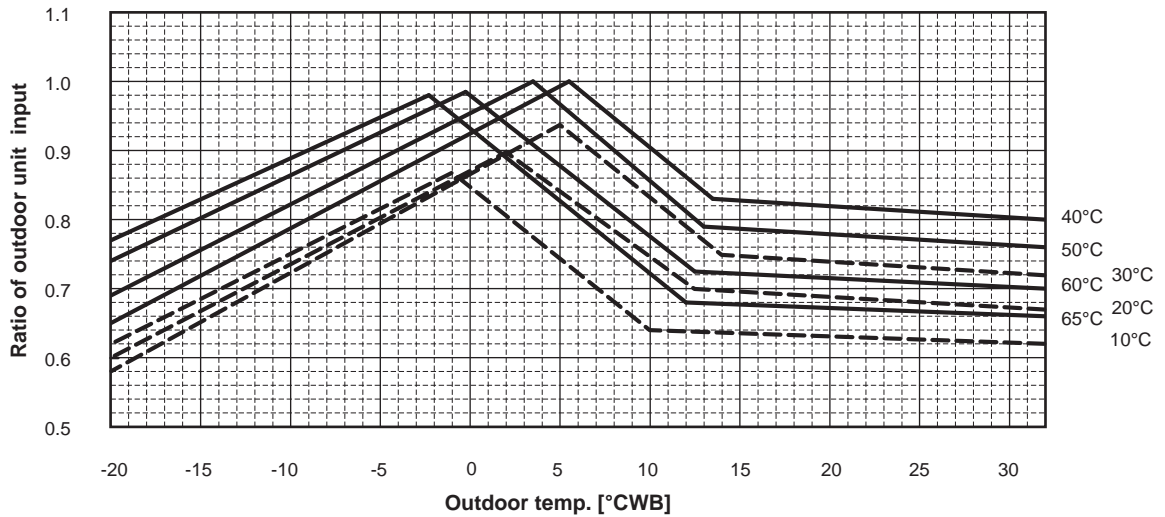
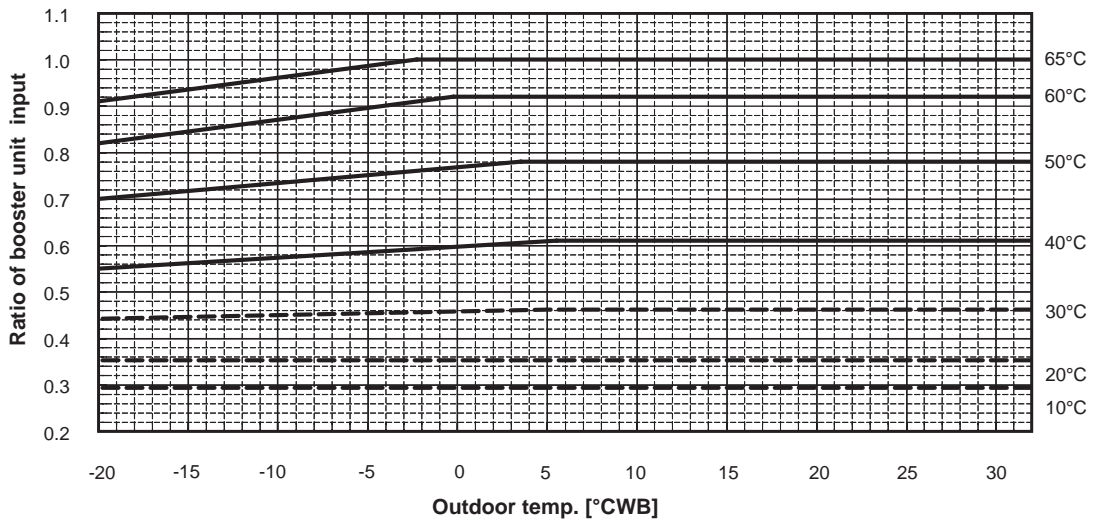
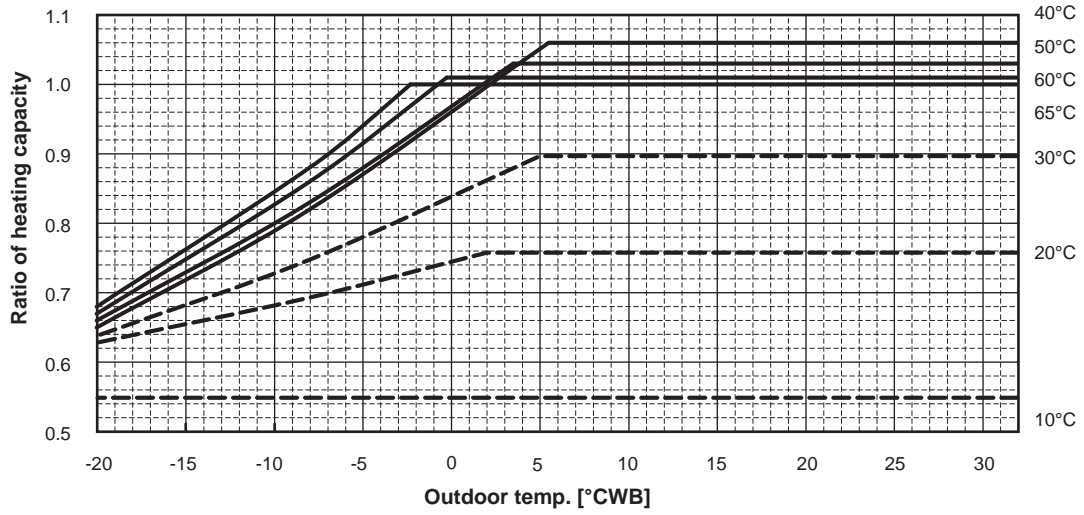

PURY- P700,750,800YHM-A

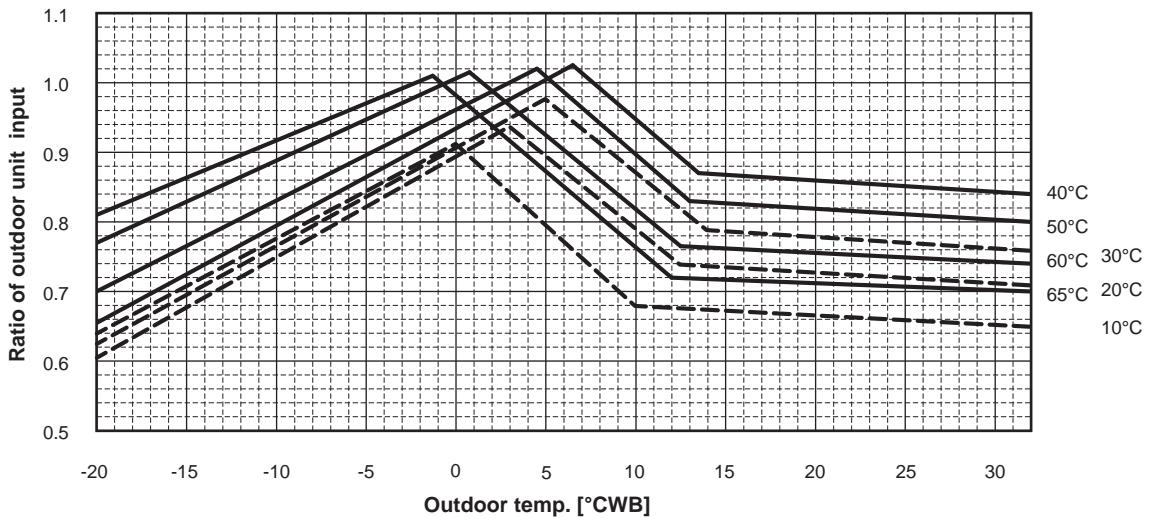
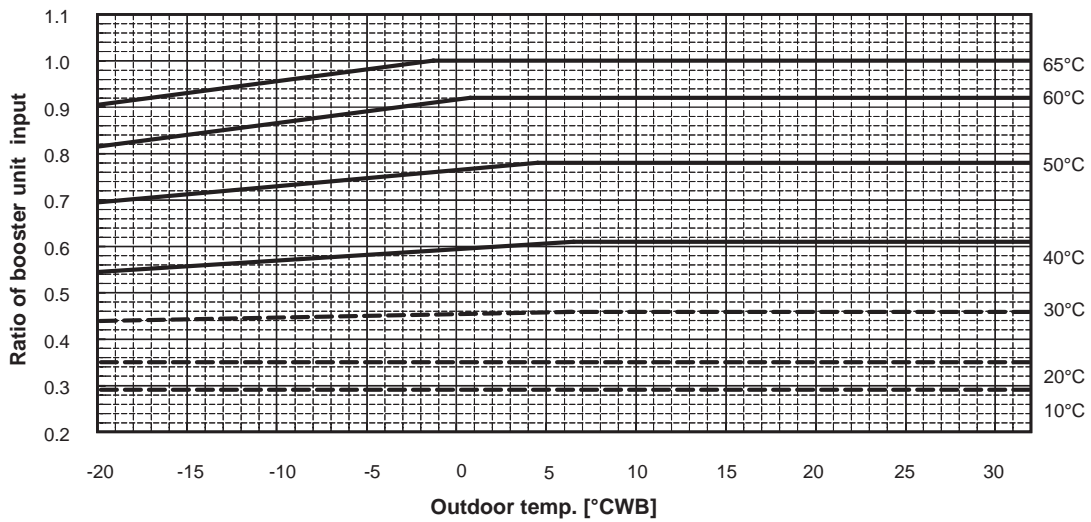
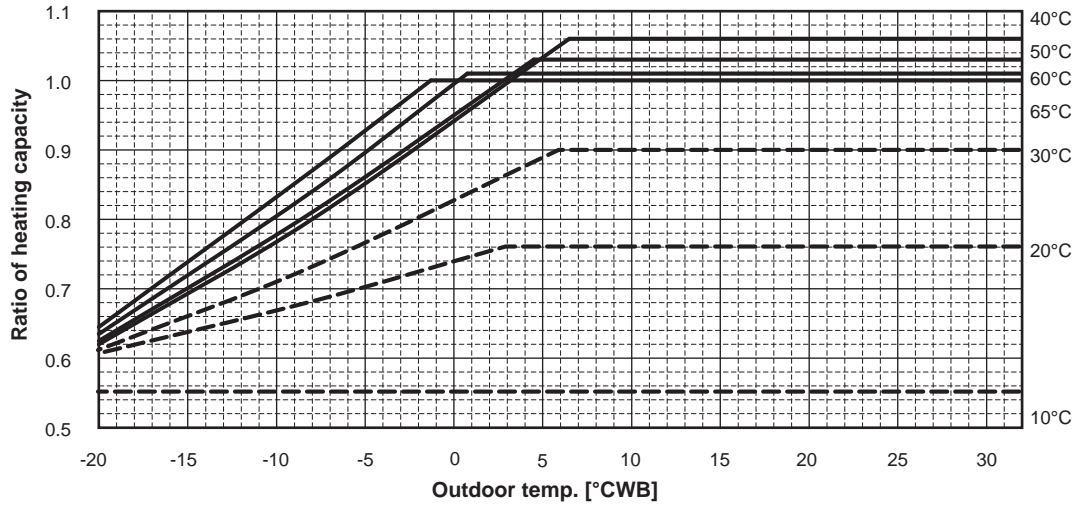

(1)-2 PWFY-P100, 200VM-E-AU

PUHY-	P200,250YHM-A	EP200YHM-A
-------	---------------	------------

Heating

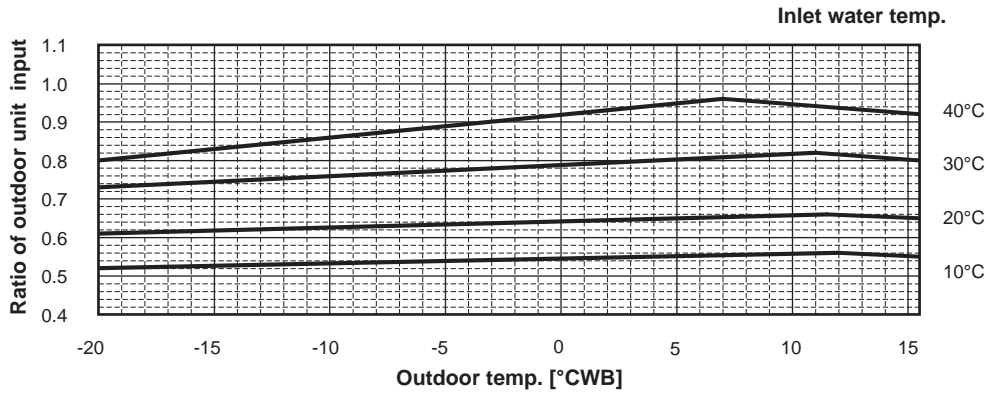
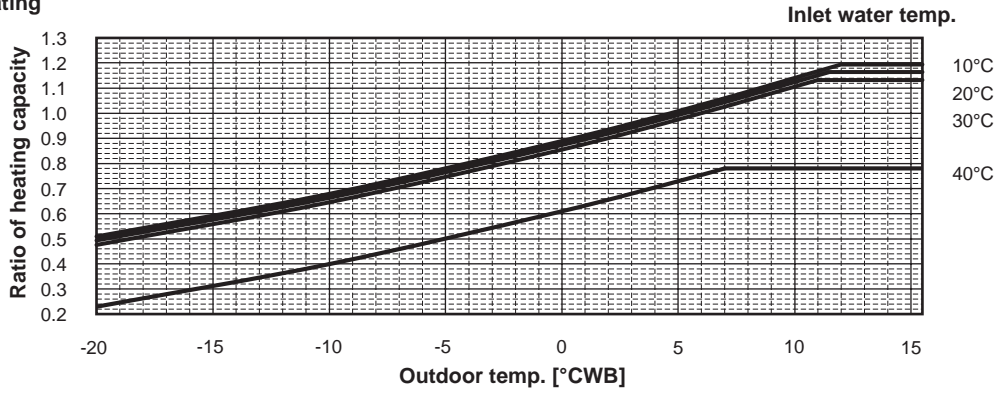

Cooling

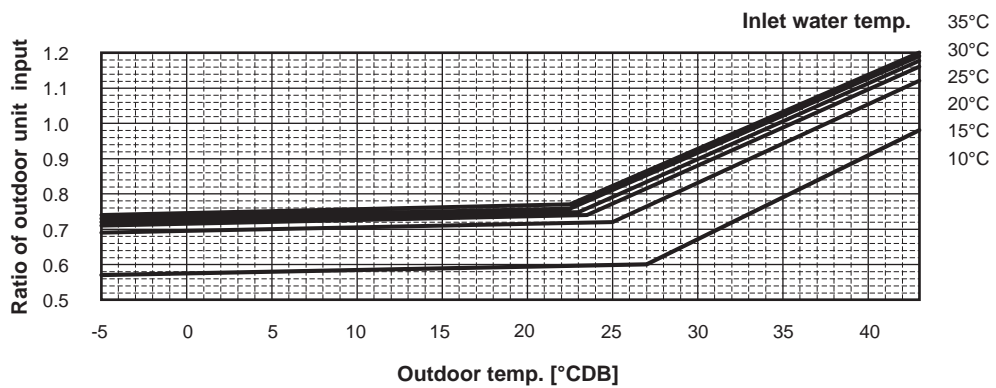
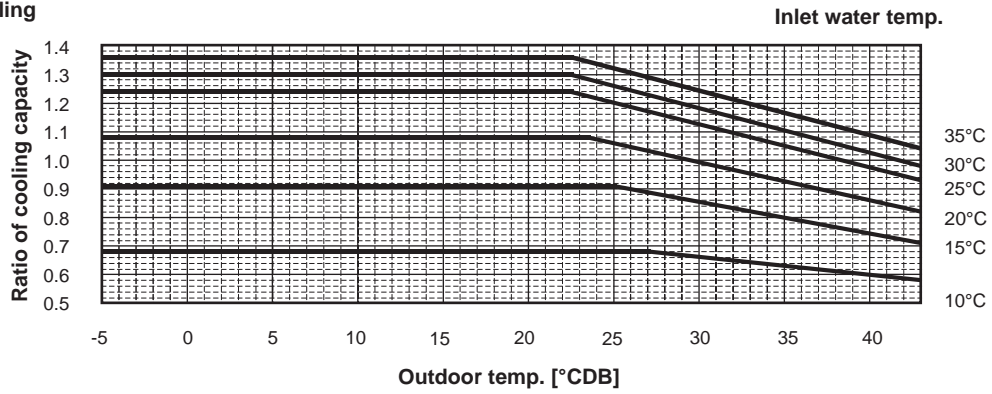

PUHY- P300,350,400YHM-A EP300,400YHM-A

Heating

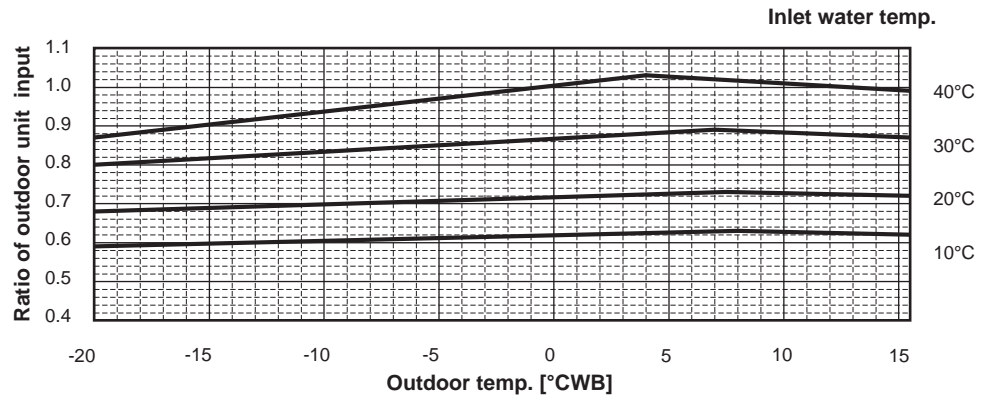
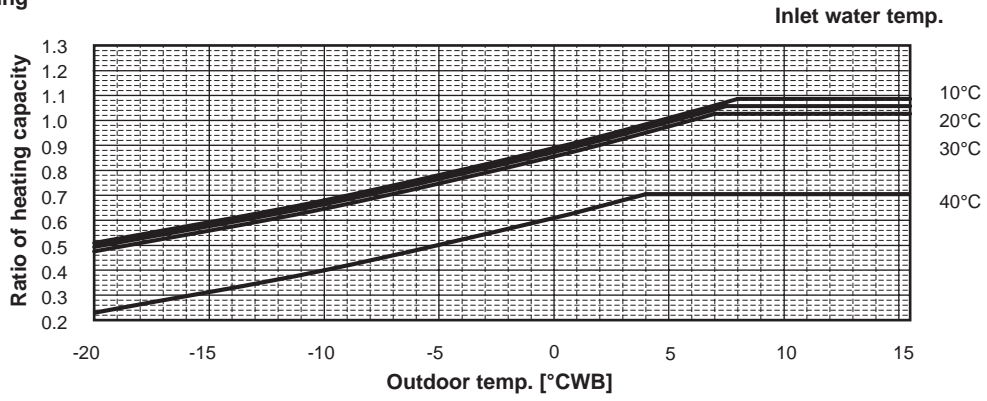

Cooling

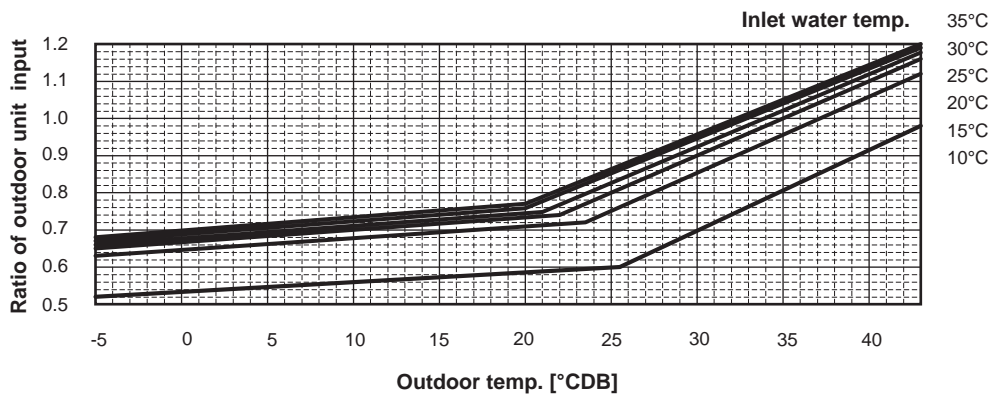
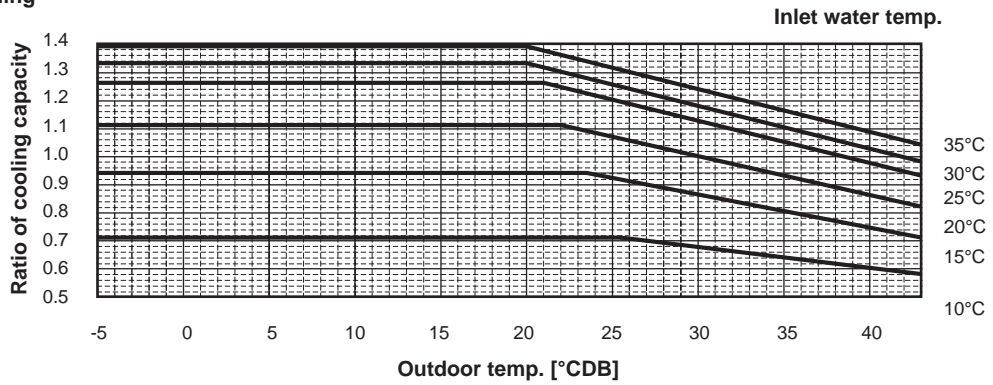

PUHY-	P450,500,550,600,650YHM-A	EP450,500,550,600,650YHM-A
-------	---------------------------	----------------------------

**Heating**

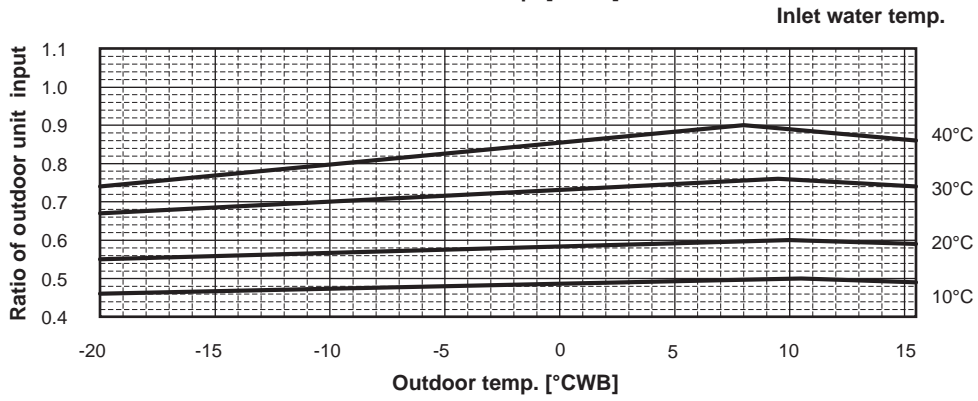
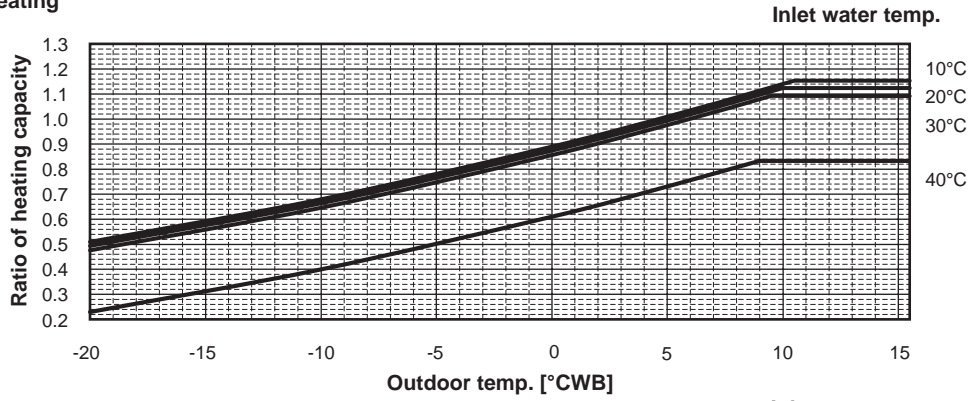

**Cooling**

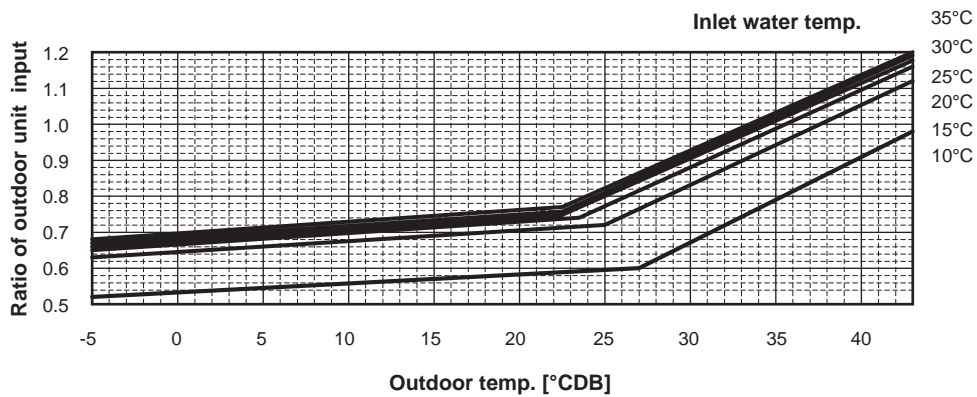
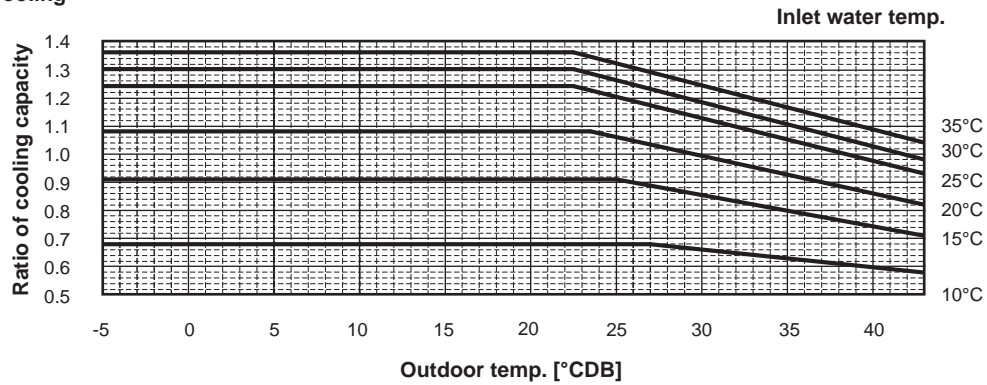

PUHY-	P700,750,800YHM-A	EP700,750,800YHM-A
-------	-------------------	--------------------

**Heating**

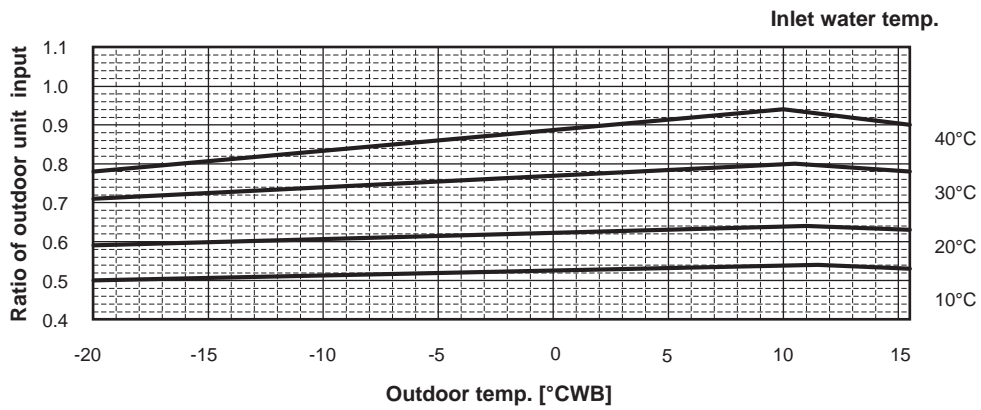
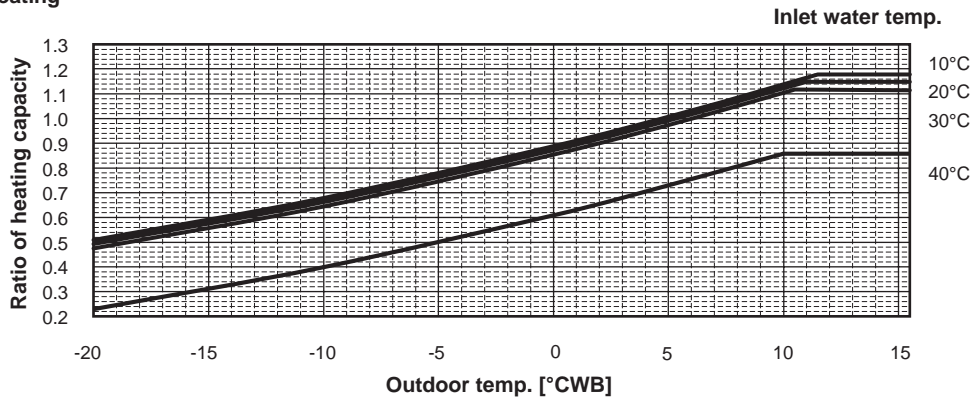

**Cooling**

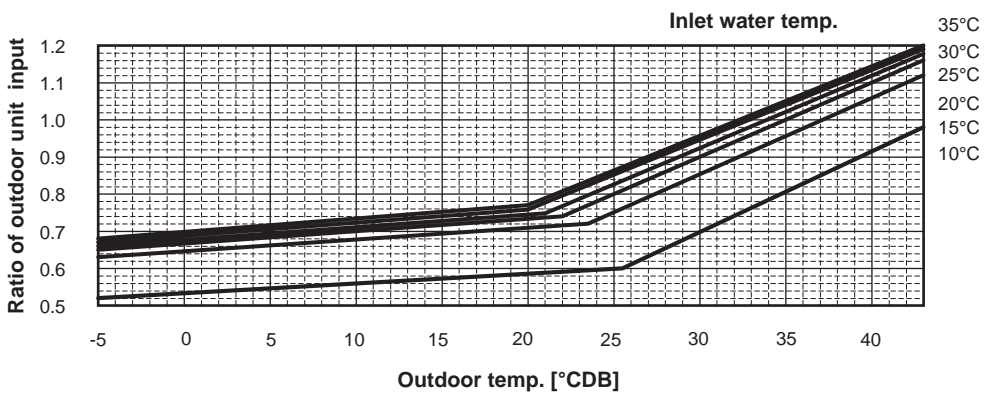
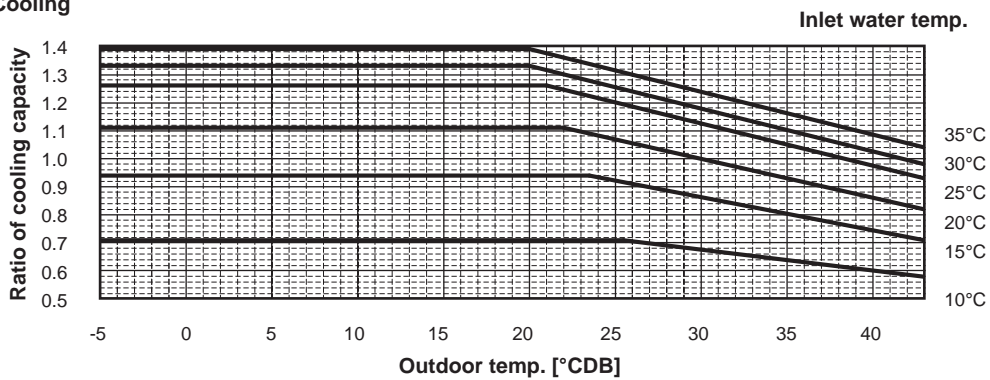



PUHY-	P850,900,950,1000,1050,1100,1150,1200,1250YHM-A	EP850,900YHM-A
-------	---	----------------

**Heating**

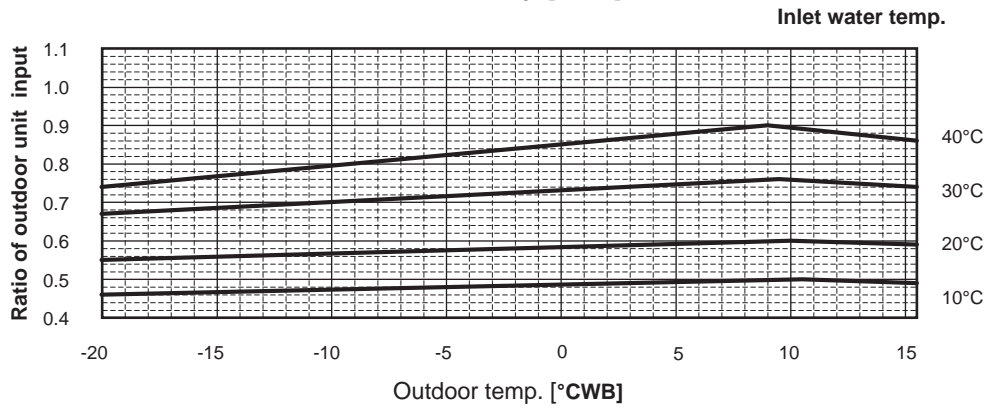
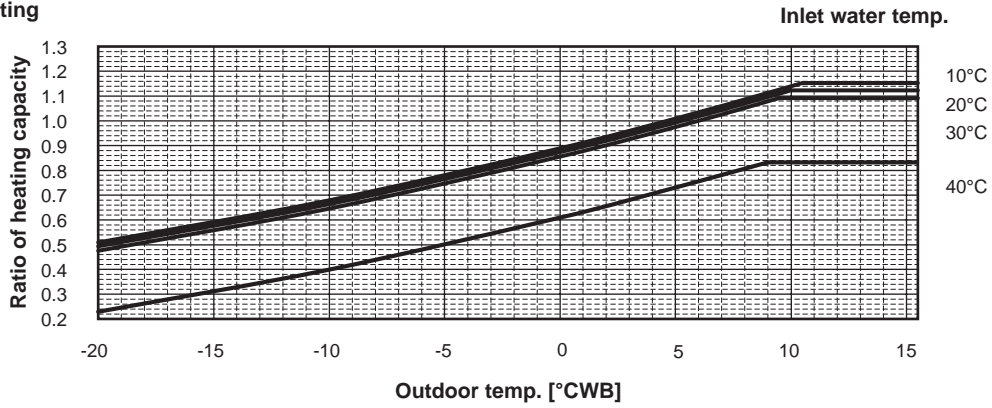

**Cooling**

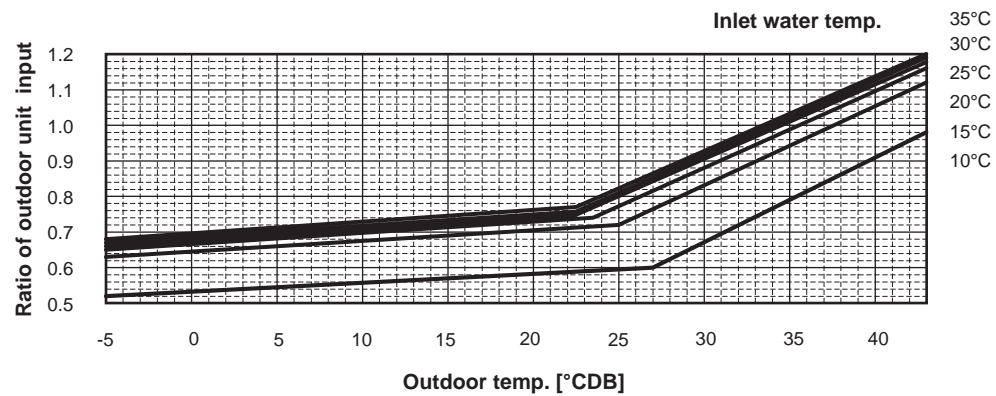
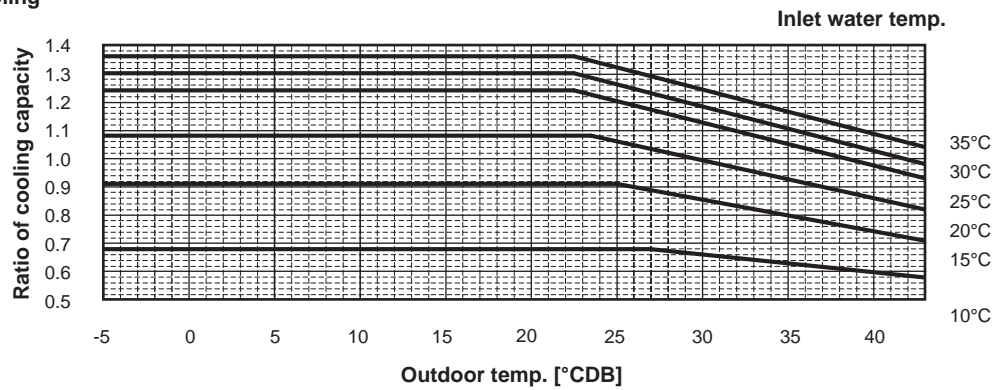

PURY-	P200,250YHM-A	EP200YHM-A
-------	---------------	------------

**Heating**

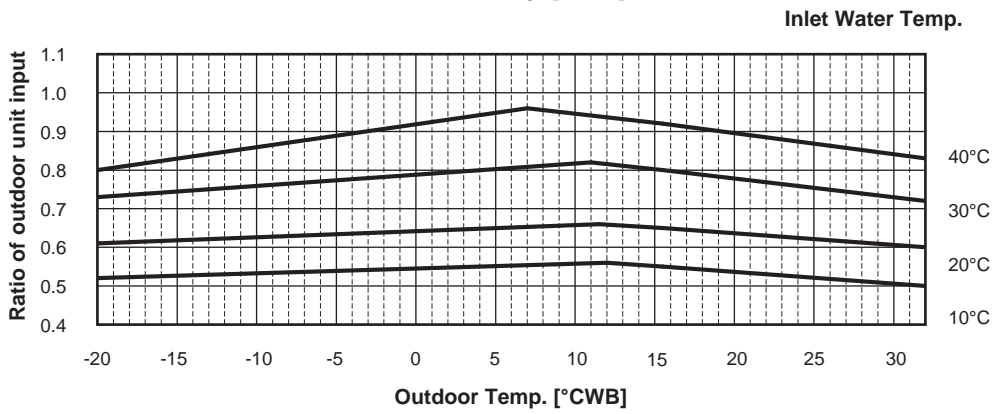
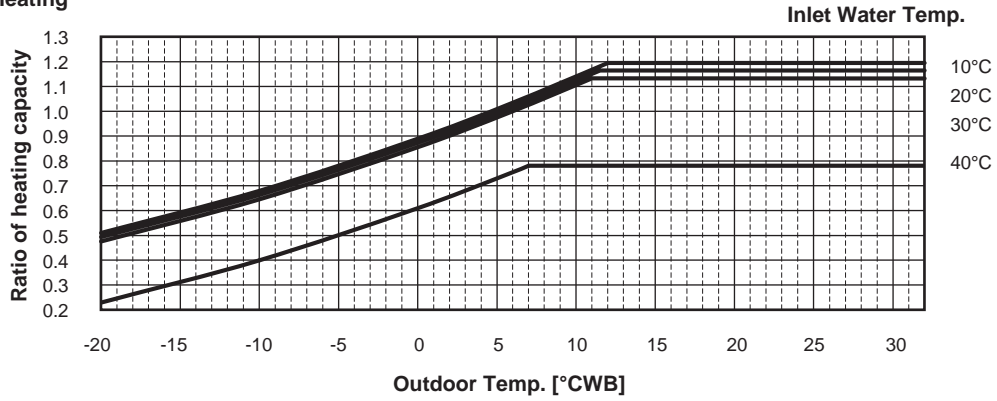

**Cooling**

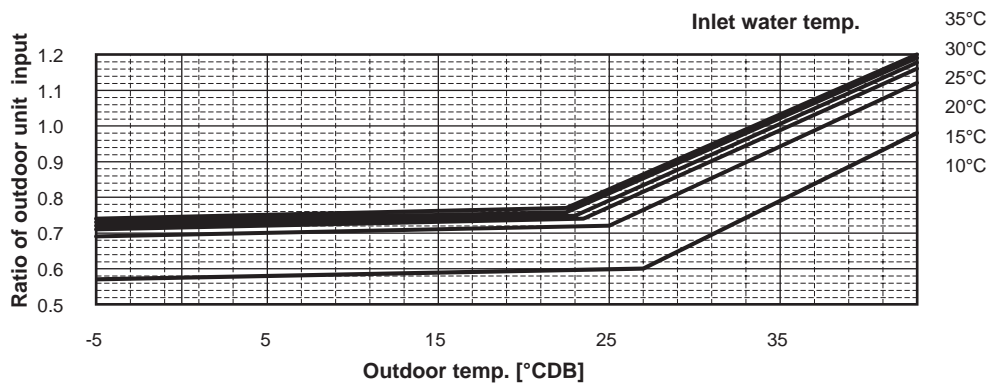
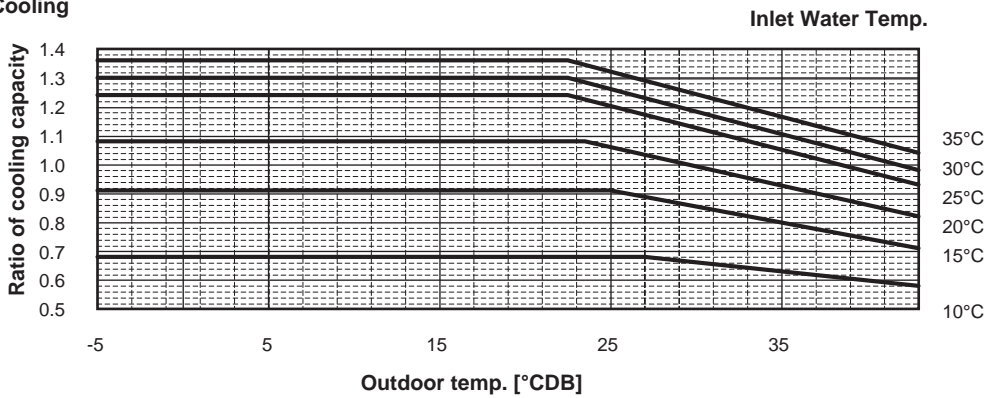

PURY-	P300,350,400YHM-A	EP300,400YHM-A
-------	-------------------	----------------

**Heating**

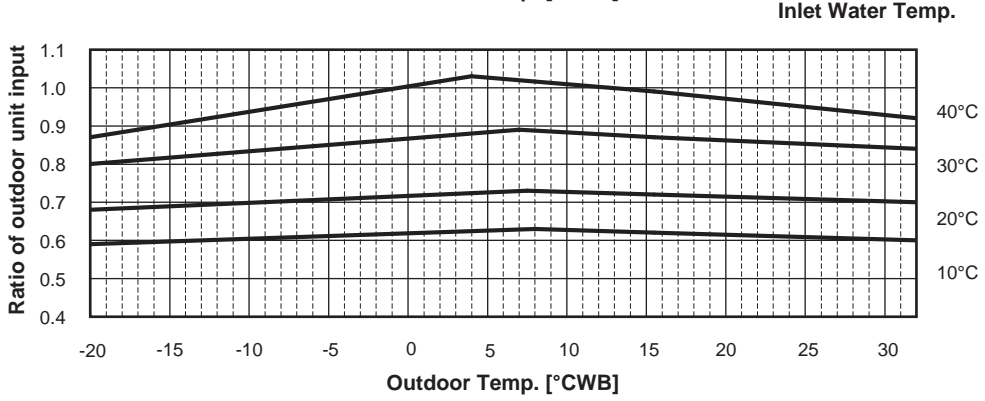
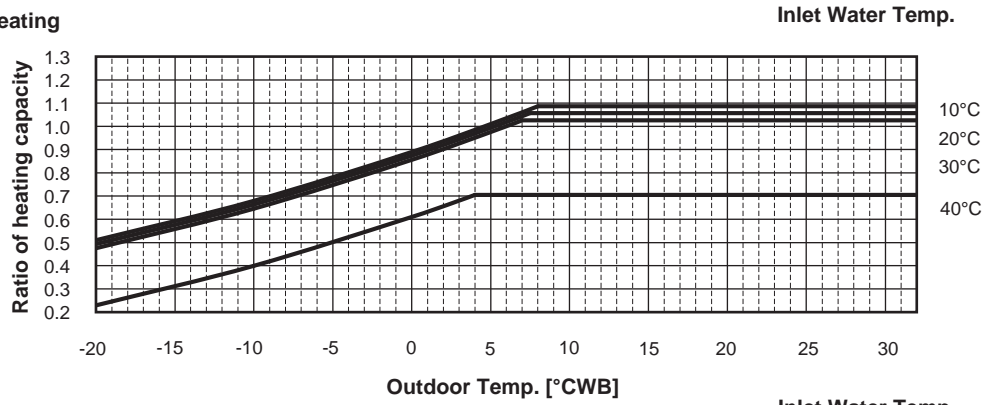

**Cooling**

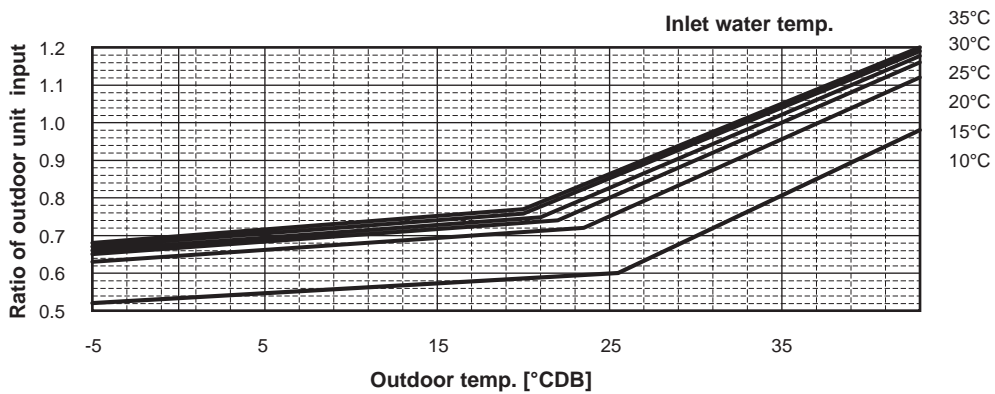
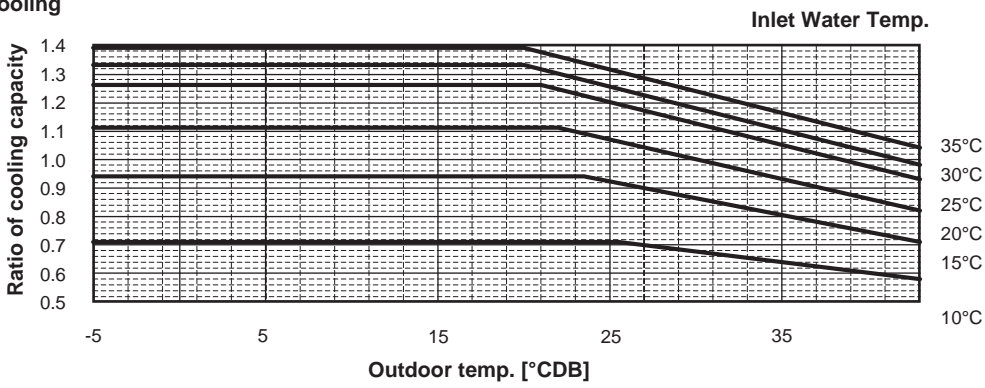

PURY-	P450,500,550,600,650YHM-A	EP450,500,550,600YHM-A
-------	---------------------------	------------------------

**Heating**

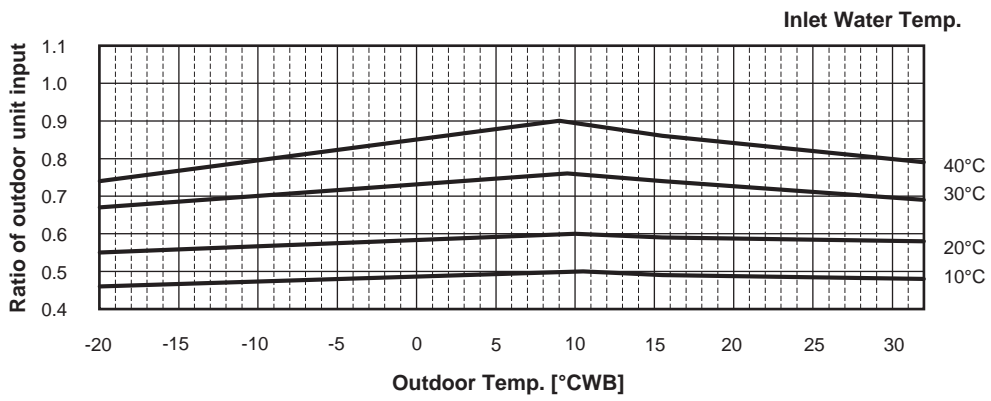
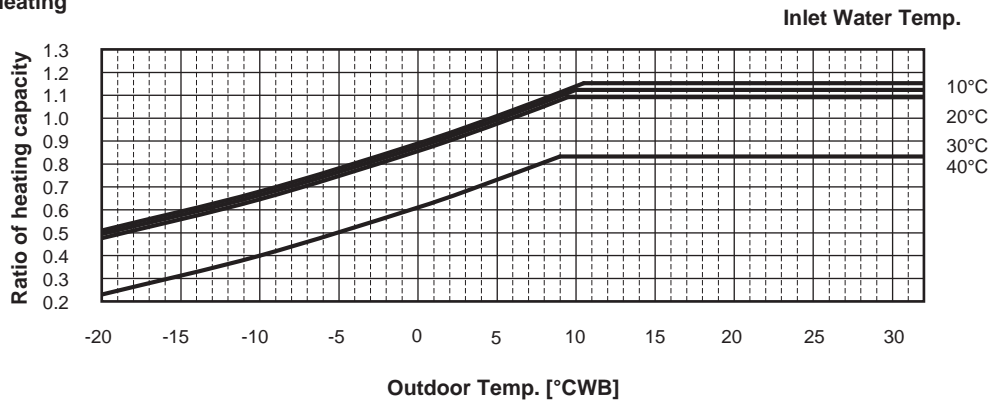

**Cooling**

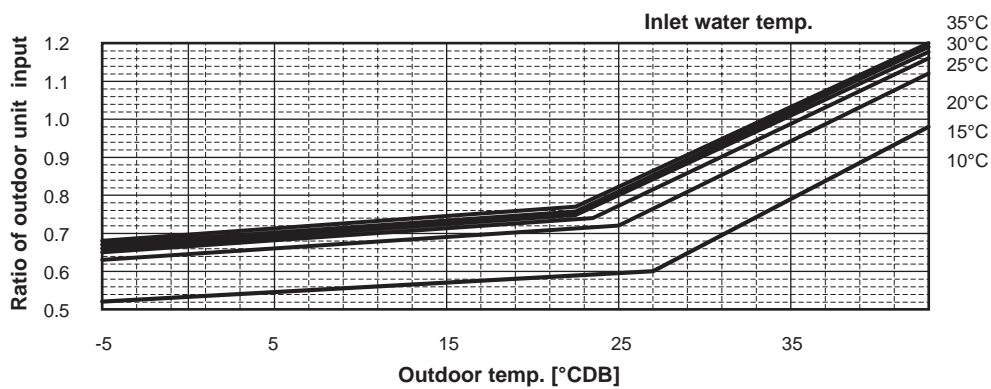
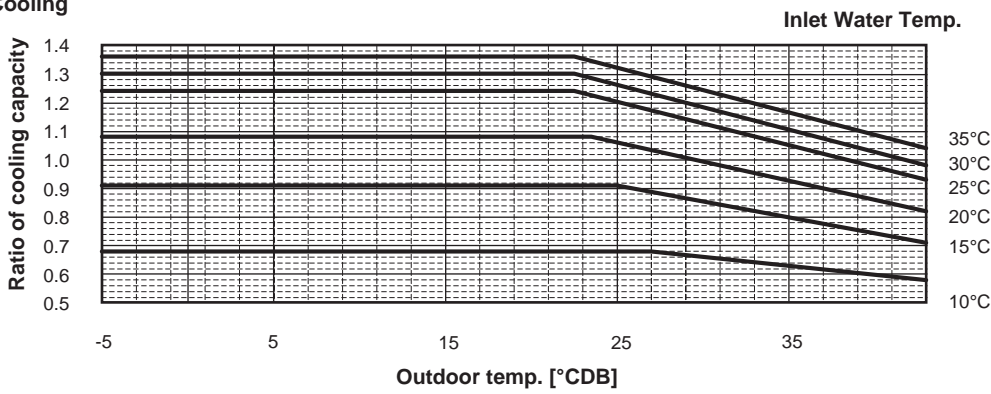

PURY- P700,750,800YHM-A

Heating

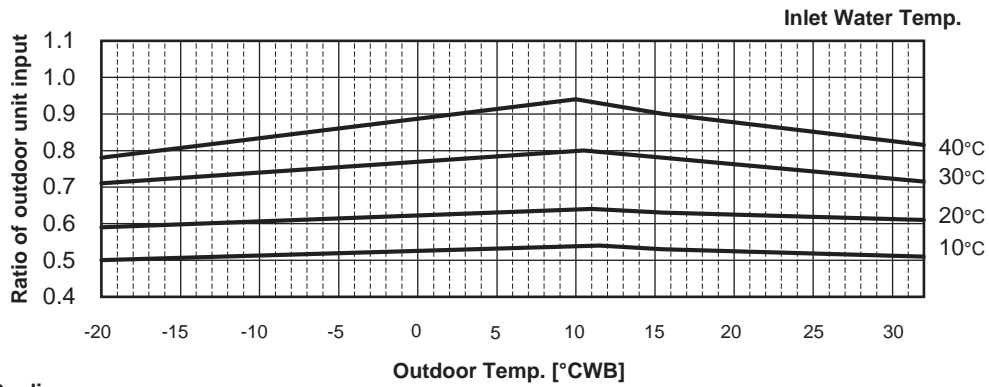
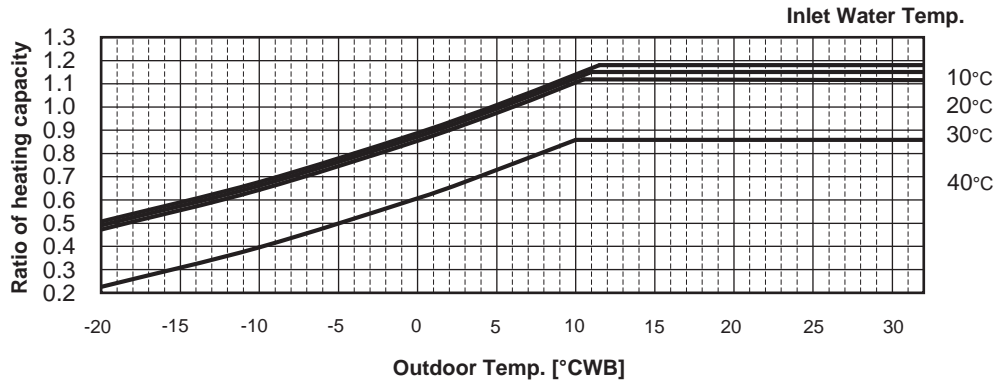

Cooling

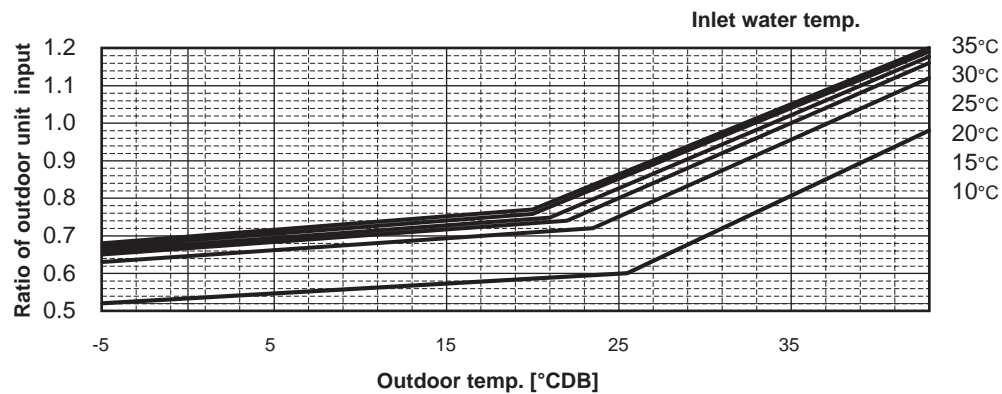
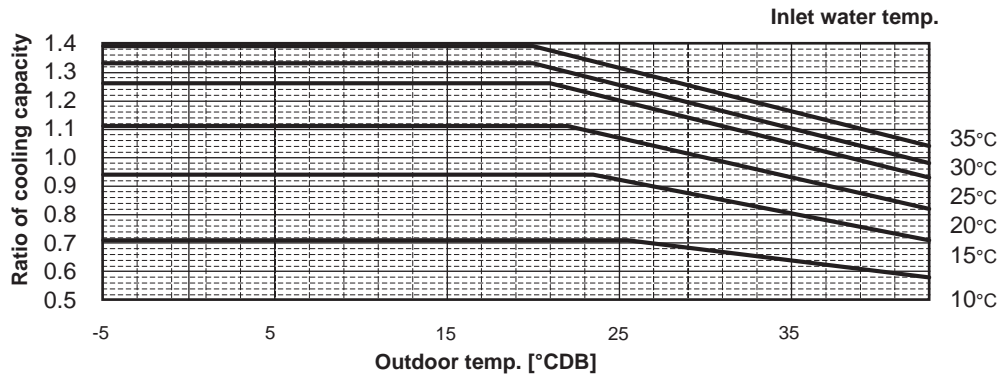

(2) Correction by water flow rate

(2)-1 PWFY-P100VM-E-BU

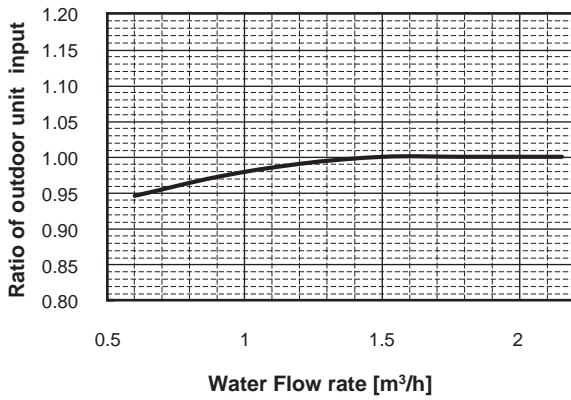
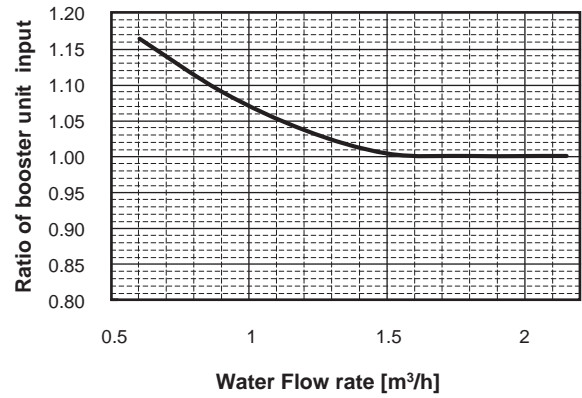
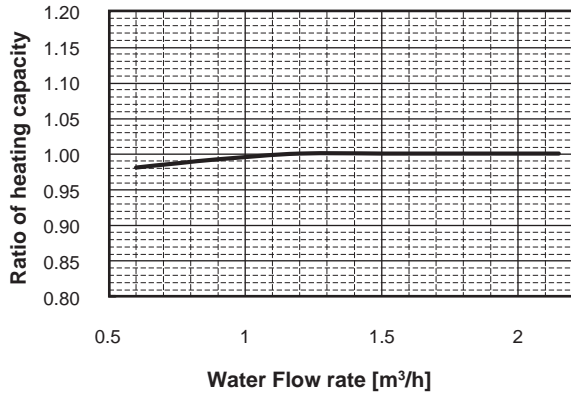

(2)-2 PWFY-P100VM-E-AU

Heating

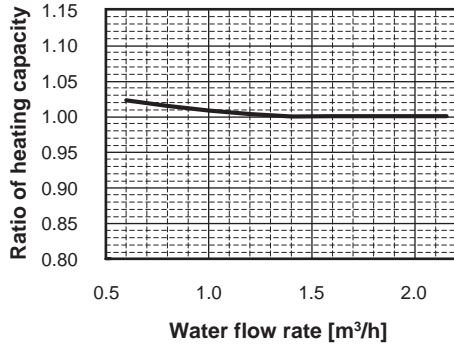

Cooling

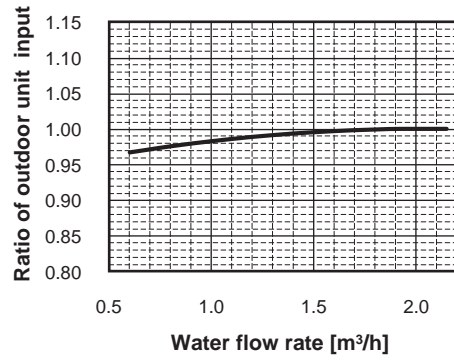
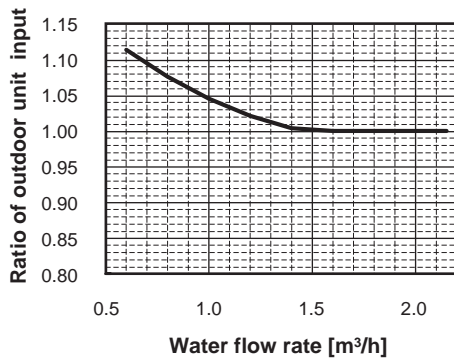
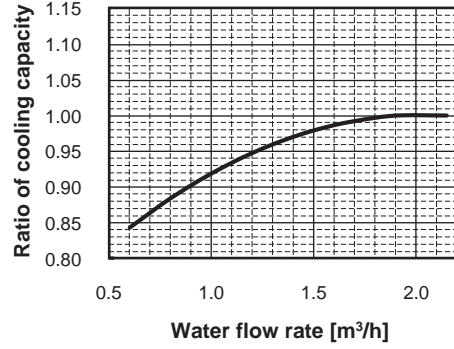

(2)-3 PWFY-P200VM-E-AU

Heating

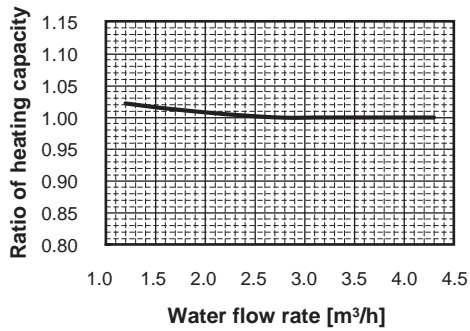

Cooling

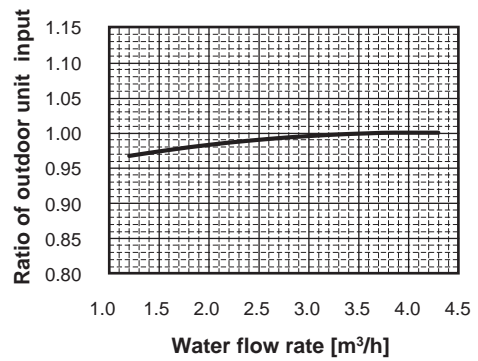
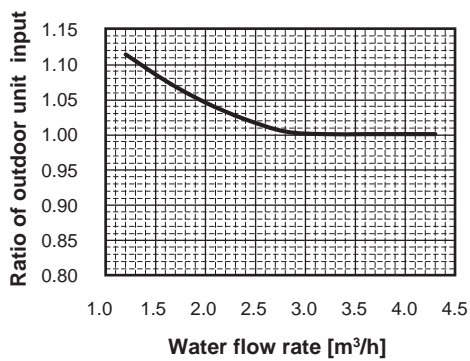
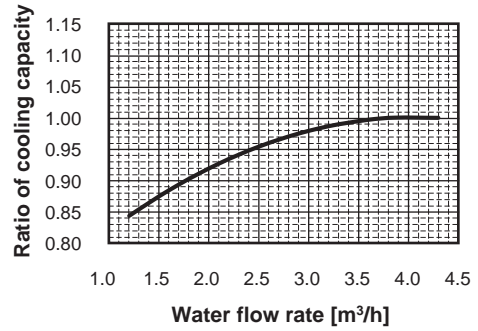

(3) Correction by total indoor

Refer to Chapter IX.

(4) Correction by refrigerant piping length

Refer to Chapter IX.

(5) Correction at frosting and defrosting

Refer to Chapter IX.

(6) Water pressure drop

(6)-1 PWFY-P100VM-E-BU

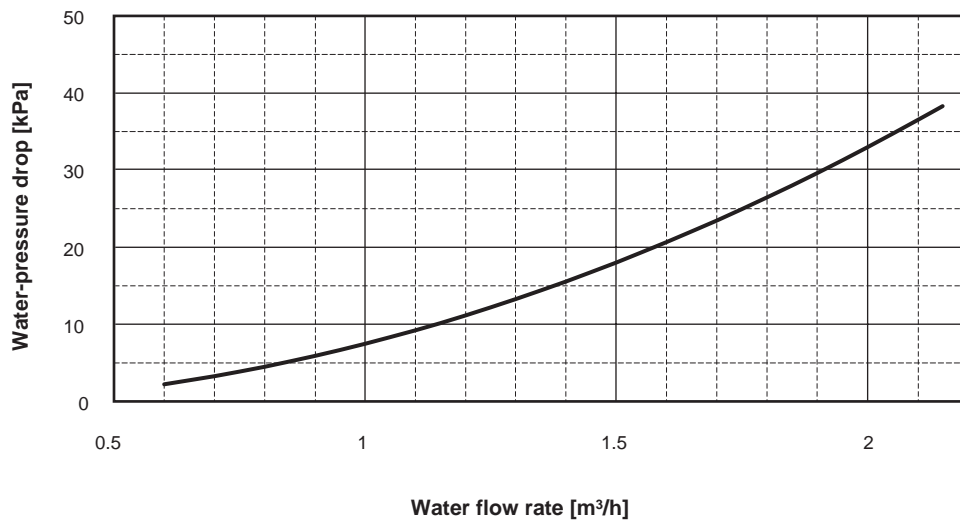

(6)-2 PWFY-P100, 200VM-E-AU

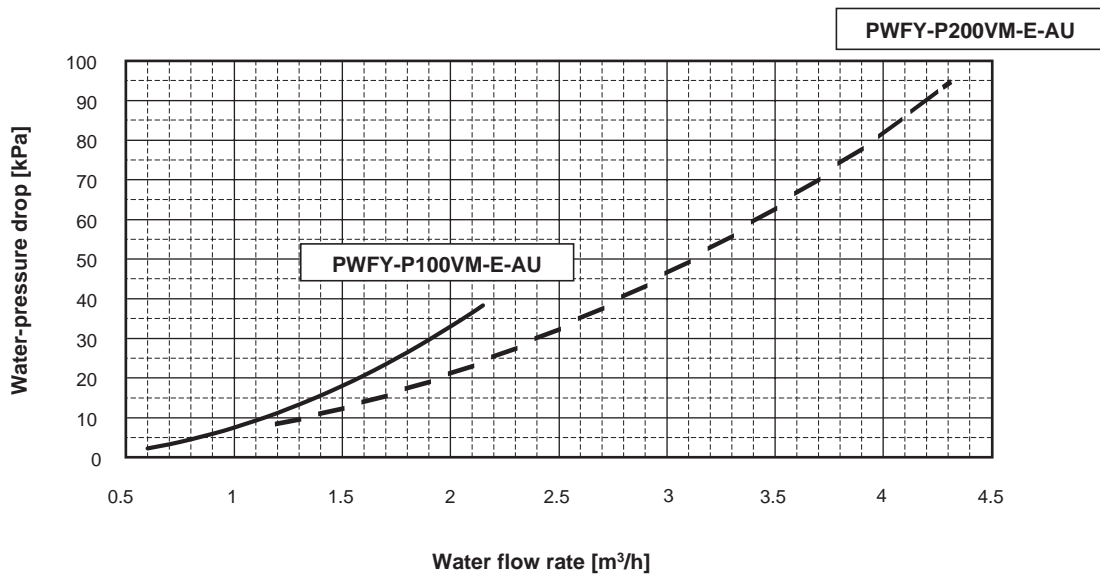



(7) Temperature range of running

(7)-1 PWFY-P100VM-E-BU

Heating

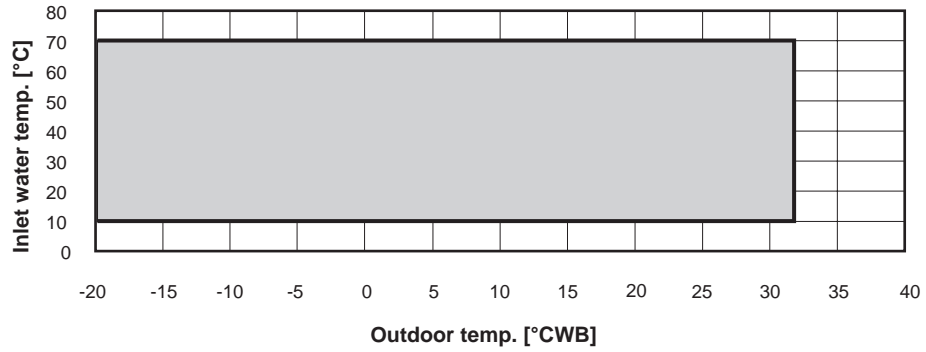

(7)-2 PWFY-P100, 200VM-E-AU

Heating

PUHY-(E)P-Y(S)HM-A-(BS)

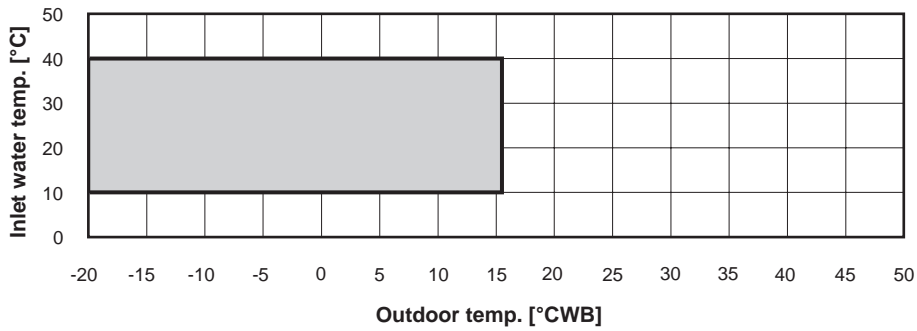

PURY-(E)P-Y(S)HM-A-(BS)

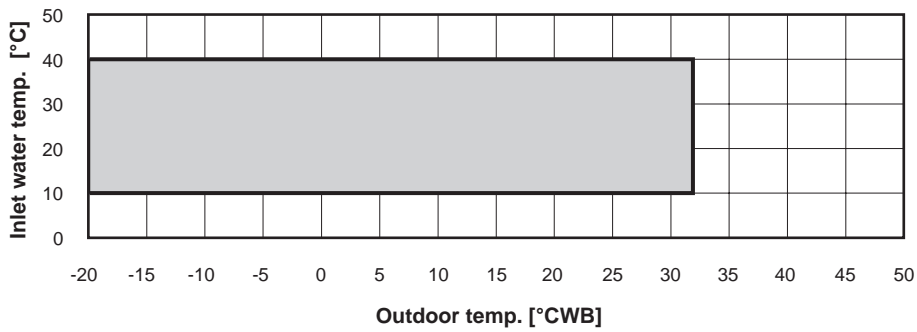

Cooling

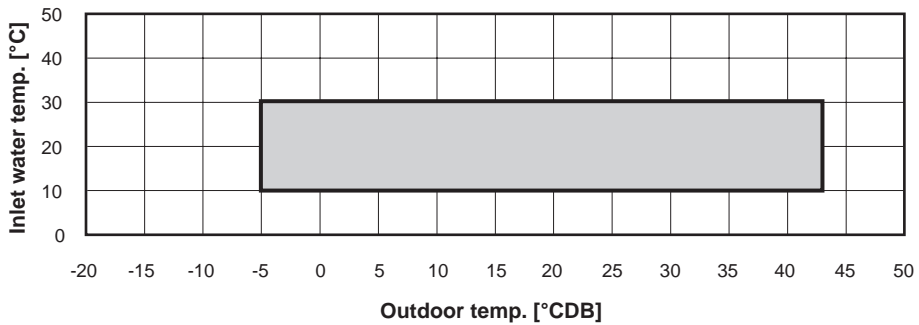

## 2. Sound levels

### (1) PWFY-P100VM-E-BU

Measurement condition  
PWFY-P100VM-E-BU

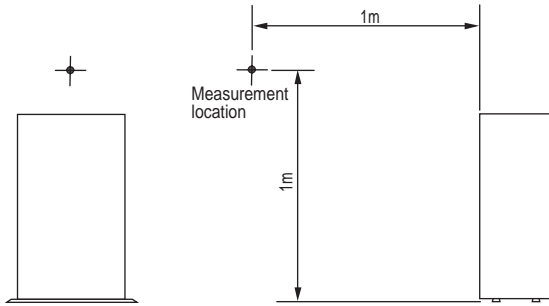

Sound level of PWFY-P100VM-E-BU

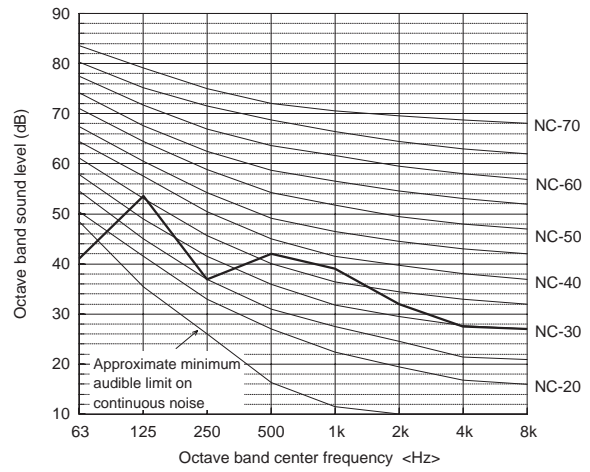

	63	125	250	500k	1k	2k	4k	8k	dB(A)
50/60Hz	41.0	53.5	37.0	42.0	39.0	32.0	27.5	27.0	44.0

When Low noise mode is set, the A/C system's capacity is limited. The system could return to normal operation from Low noise mode automatically in the case that the operation condition is severe.

### (2) PWFY-P100, 200VM-E-AU

Measurement condition  
PWFY-P100, 200VM-E-AU

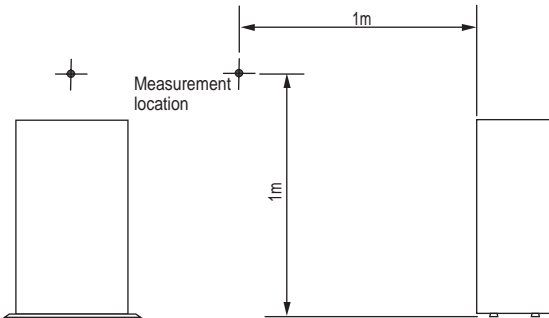

Sound level of PWFY-P100, 200VM-E-AU

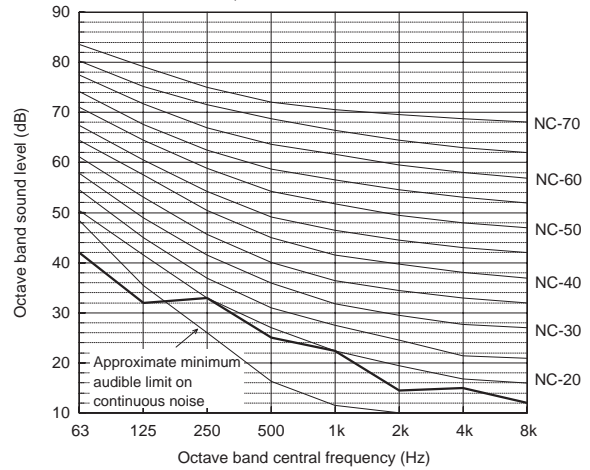

	63	125	250	500k	1k	2k	4k	8k	dB(A)
50/60Hz	42.0	32.0	33.0	25.0	22.5	14.5	15.0	12.0	29.0

When Low noise mode is set, the A/C system's capacity is limited. The system could return to normal operation from Low noise mode automatically in the case that the operation condition is severe.

---

### 3. Vibration levels

(1) PWFY-P100VM-E-BU

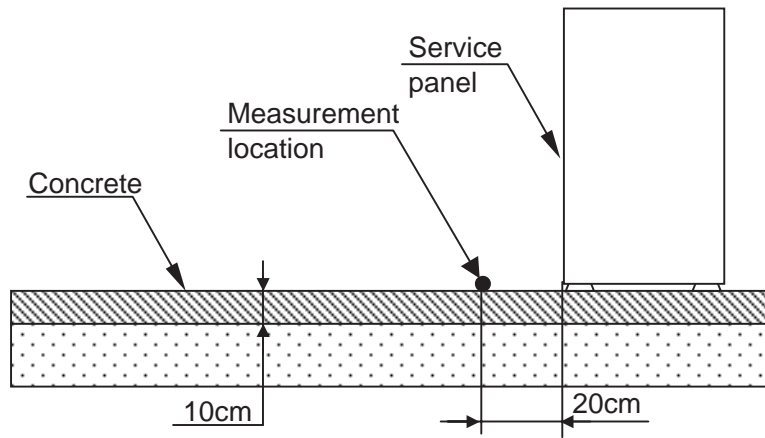

Model	Vibration Levels[dBA]
PWFY-P100VM-E-BU	34

## 4. Refrigerant circuit diagrams and thermal sensors

### (1) PWFY-P100VM-E-BU

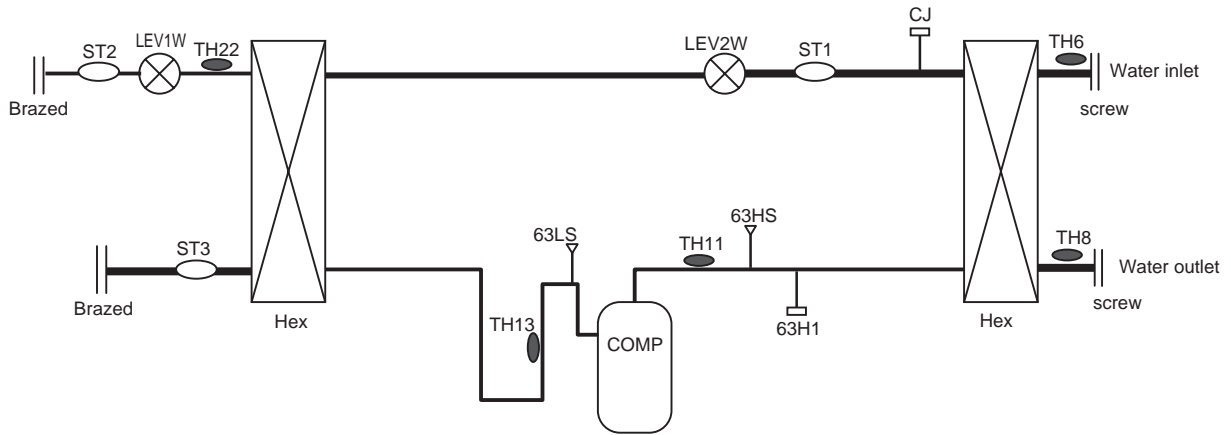

### (2) PWFY-P100VM-E-AU

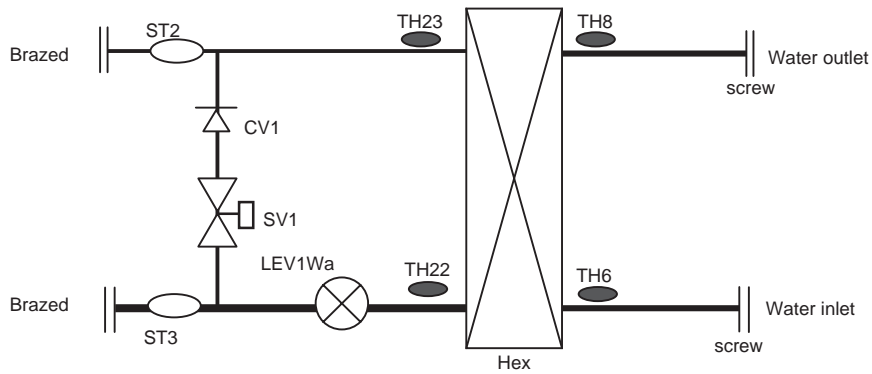

### (3) PWFY-P200VM-E-AU

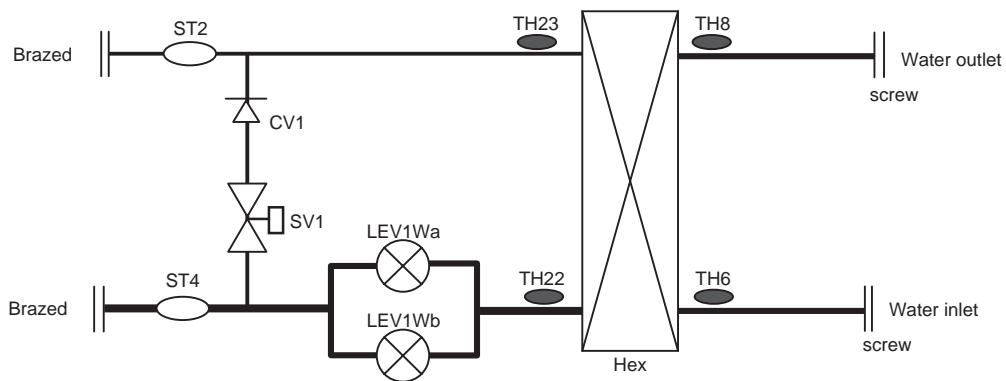

# IV Installation

## 1. How to calculate the necessary heat capacity

### (1) Heating capacity calculation

A. For Air conditioning using such as Panel Heaters, Floor Heating and Fan coil units

Required total heating capacity  kW

Safety factor;  %

B. For Sanitary use such as Shower and Bathrooms

Conditions

Tank inlet water Temp.;  °C

Tank outlet water Temp.;  °C

(Set Temp -5 °C)

Safety factor for Heat Loss;  %

Operating time;  Hours

For Shower;  ℓ/person x  Person =  ℓ (Water Temp. Condition  °C)

For Bathrooms;  ℓ/Person x  Person =  ℓ (Water Temp. Condition  °C)

(The examples of water volume might be need to be changed as you need.)

The conversion of water volume to  °C

$$\frac{\text{9}}{\text{4}} \times \left( \frac{\text{10}}{\text{3}} - \frac{\text{3}}{\text{3}} \right) / \left( \frac{\text{4}}{\text{4}} - \frac{\text{3}}{\text{3}} \right)$$

$$+ \frac{\text{13}}{\text{4}} \times \left( \frac{\text{14}}{\text{3}} - \frac{\text{3}}{\text{3}} \right) / \left( \frac{\text{4}}{\text{4}} - \frac{\text{3}}{\text{3}} \right)$$

$$= \text{15} / \text{day}$$

Heating Capacity Calculation for sanitary usage

$$\frac{\text{15}}{1,000} \times \left( \frac{\text{4}}{\text{3}} - \frac{\text{3}}{\text{3}} \right) = \text{16} \text{ M cal / day}$$

The conversion of M cal to kW

$$\frac{\text{16}}{860} \times 1,000 / \text{6} = \text{17} \text{ kW}$$

C. Total (A+B)

Total Heating Capacity

$$\text{1} \times (100\% + \text{2}\%) + \text{17} \times (100\% + \text{5}\%) = \text{18} \text{ kW}$$

D. No. of units required

Safety factor;  %

$$\frac{\text{18} \times (100\% + \text{19}\%)}{12.5 \text{ kW}} = \text{20} \text{ units}$$



units are required

### (2) A calculation example

A. For Air conditioning using such as Panel Heaters, Floor Heating and Fan coil units

Required total heating capacity  kW

Safety factor;  %

B. For Sanitary use such as Shower and Bathrooms

Conditions

Tank inlet water Temp.;  °C

Tank outlet water Temp.;  °C

(Set Temp -5 °C)

Safety factor for Heat Loss;  %

Operating time;  Hours

For Shower;  ℓ/person x  Person =  ℓ (Water Temp. Condition  °C)

For Bathrooms;  ℓ/Person x  Person =  ℓ (Water Temp. Condition  °C)

(The examples of water volume might be need to be changed as you need.)

The conversion of water volume to  °C

$$\frac{\text{1,200}}{\text{60}} \times \left( \frac{\text{40}}{\text{10}} - \frac{\text{10}}{\text{10}} \right) / \left( \frac{\text{60}}{\text{60}} - \frac{\text{10}}{\text{10}} \right)$$

$$+ \frac{\text{240}}{\text{60}} \times \left( \frac{\text{45}}{\text{10}} - \frac{\text{10}}{\text{10}} \right) / \left( \frac{\text{60}}{\text{60}} - \frac{\text{10}}{\text{10}} \right)$$

$$= \text{888} / \text{day}$$

Heating Capacity Calculation for sanitary usage

$$\frac{\text{888}}{1,000} \times \left( \frac{\text{60}}{\text{10}} - \frac{\text{10}}{\text{10}} \right) = \text{44.4} \text{ M cal / day}$$

The conversion of M cal to kW

$$\frac{\text{44.4}}{860} \times 1,000 / \text{8} = \text{6.45} \text{ kW}$$

C. Total (A+B)

Total Heating Capacity

$$\text{20} \times (100\% + \text{10}\%) + \text{6.45} \times (100\% + \text{15}\%) = \text{29.42} \text{ kW}$$

D. No. of units required

Safety factor;  %

$$\frac{\text{29.42} \times (100\% + \text{20}\%)}{12.5 \text{ kW}} = \text{2.82} \text{ units}$$



units are required

---

## 2. Installation

### (1) Selecting an installation site

- **Do not install outdoors. The unit is not waterproof.**
- **Back up system is recommended in case of PWFY unit breakdown.**
- **The unit will get hot. Do not install in a location where heat gets trapped inside.**
- **Be sure to install unit in a place strong enough to withstand its weight.**  
Any lack of strength may cause unit to fall down, resulting in a personal injury.
- **Do not install the unit where corrosive gas is generated.**
- **Have installation work in order to protect against earthquake.**  
Any installation deficiency may cause unit to fall down, resulting in a personal injury.
- **Pay a special attention to the place, such as a basement, etc. where refrigeration gas can stay, since refrigeration is heavier than the air.**
- **Do not install the unit where combustible gas may leak.**
  - If the gas leaks and accumulates around the unit, an explosion may result.
- **When installing the unit in a hospital, communication station, or similar place, provide sufficient protection against noise.**
  - The inverter equipment, private power generator, high-frequency medical equipment, or radio communication equipment may cause the air conditioner to operate erroneously, or fail to operate. On the other hand, the air conditioner may affect such equipment by creating noise that disturbs medical treatment or image broadcasting.
- **Do not install the unit on a structure that may cause leakage.**
  - When the room humidity exceeds 80 % or when the drain pipe is clogged, condensation may drip from the indoor unit. Perform collective drainage work together with the unit, as required.

### (1)-1 Securing installation and service space

- Please allow for the following service spaces after installation.  
(All servicing can be performed from the front of the unit)  
[Fig. IV. 2. (1). 1]

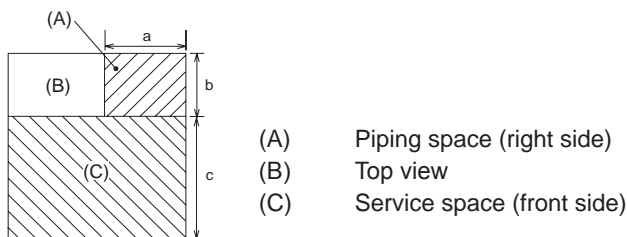

#### **⚠ Warning:**

- **Be sure to install the unit in a location which can adequately support its weight.**
  - If there is insufficient strength to support the unit's weight, it could fall and cause injuries.

### (1)-2 Combining indoor units with BC controllers and outdoor units

For combining indoor units with BC controllers and outdoor units, refer to section BC controllers and outdoor units installation manual.

## (2) Installing the unit

### (2)-1 Lifting method

#### ⚠ Caution:

#### Be very careful when carrying the product.

- Do not have only one person to carry product if it is more than 20 kg.
- Do not tilt the unit while transporting.
- PP bands are used to pack some products. Do not use them as a mean for transportation because they are dangerous.
- Tear plastic packaging bag and scrap it so that children cannot play with it. Otherwise plastic packaging bag may suffocate children to death.

### (2)-2 Product net weight

Model	PWFY-P100VM-E-BU	PWFY-P100VM-E-AU	PWFY-P200VM-E-AU
Net weight	60 kg	35 kg	38 kg

### (2)-3 Center of gravity

#### (2)-3-1 PWFY-P100VM-E-BU

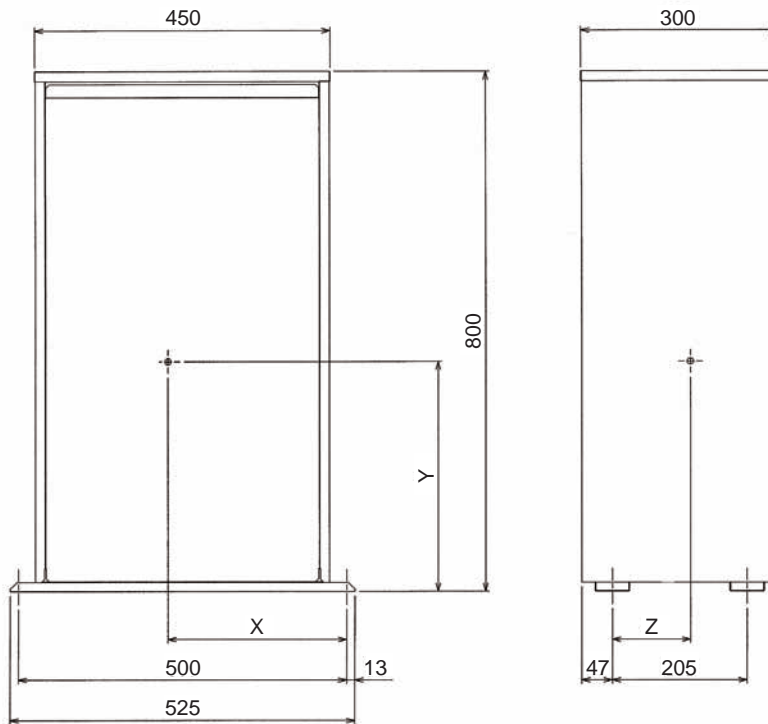

Model	X	Y	Z
PWFY-P100VM-E-BU	272	355	119

(2)-3-2 PWFY-P100, 200VM-E-AU

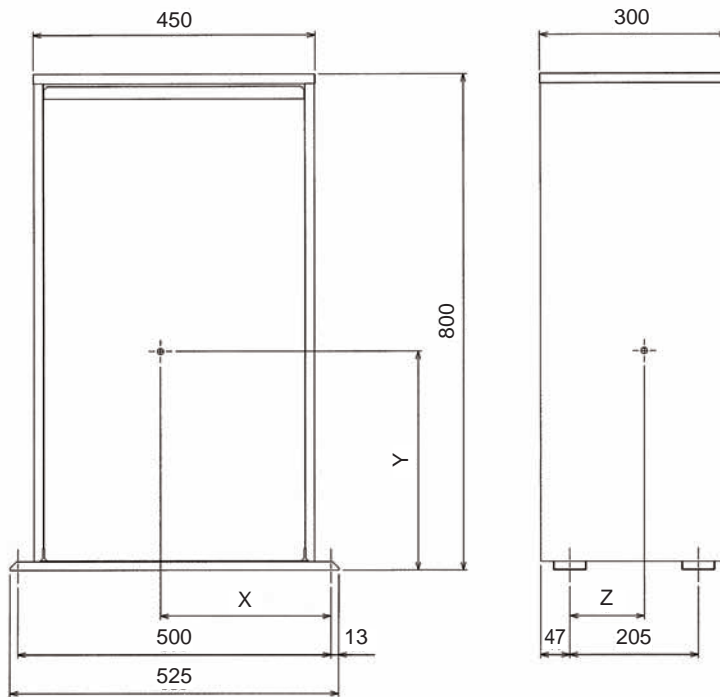

Model	X	Y	Z
PWFY-P100VM-E-AU	289	346	103
PWFY-P200VM-E-AU	277	347	99

(2)-4 Installation method

- Using the anchoring holes shown below, firmly bolt the unit to the base.  
[Fig. IV. 2. (2). 1]

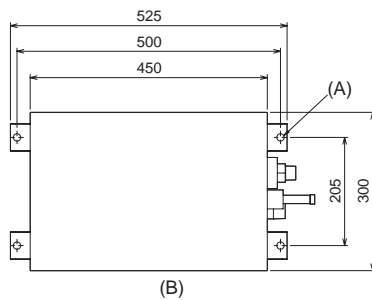

(A) 4- $\phi$ 14 (Anchoring hole)  
(B) (Top view)

**Bases**

- Be sure to install unit in a place strong enough to withstand its weight. If the base is unstable, reinforce with a concrete base.
- The unit must be anchored on a level surface. Use a level to check after installation.
- If the unit is installed near a room where noise is a problem, using an anti-vibration stand on the base of the unit is recommended.



### (3) Refrigerant pipe and drain pipe specifications

#### (3)-1 Refrigerant pipe and drain pipe specifications

To avoid dew drops, provide sufficient antisweating and insulating work to the refrigerant and drain pipes.

When using commercially available refrigerant pipes, be sure to wind commercially available insulating material (with a heat-resisting temperature of more than 100 °C and thickness given below) onto both liquid and gas pipes.

Be also sure to wind commercially available insulating material (with a form polyethylene's specific gravity of 0.03 and thickness given below) onto all pipes which pass through rooms.

1) Select the thickness of insulating material by pipe size.

Model	PWFY-P100VM-E-BU	PWFY-P100VM-E-AU	PWFY-P200VM-E-AU
Gas	ø15.88	ø15.88	ø19.05
Liquid	ø9.52	ø9.52	ø9.52
Drain	ø32		
Insulating material's thickness	More than 10 mm		

- 2) If the unit is used on the highest story of a building and under conditions of high temperature and humidity, it is necessary to use pipe size and insulating material's thickness more than those given in the table above.
- 3) If there are customer's specifications, simply follow them.

#### (3)-2 Refrigerant pipe, drain pipe and filling port

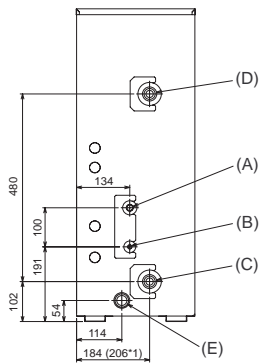

- (A) Refrigerant piping (gas)
  - (B) Refrigerant piping (liquid)
  - (C) Water inlet
  - (D) Water outlet
  - (E) Drain outlet
- \*1: PWFY-P100, 200VM-E-AU

## (4) Connecting refrigerant pipes and drain pipes

### (4)-1 Refrigerant piping work

This piping work must be done in accordance with the installation manuals for both outdoor unit and BC controller (simultaneous cooling and heating series R2).

- Series R2 is designed to operate in a system that the refrigerant pipe from an outdoor unit is received by BC controller and branches at the BC controller to connect between indoor units.
- The PWFY unit should be connected to 2 ports on the BC controller. (Set BC controller DIP SW 4-6 to ON)
- For constraints on pipe length and allowable difference of elevation, refer to the outdoor unit manual.
- The method of pipe connection is brazing connection.

#### ⚠ Caution:

- **Install the refrigerant piping for the indoor unit in accordance with the following.**

1. Cut the tip of the indoor unit piping, remove the gas, and then remove the brazed cap.  
[Fig. IV. 2. (4). 1]



2. Pull out the thermal insulation on the site refrigerant piping, braze the unit piping, and replace the insulation in its original position.  
Wrap the piping with insulating tape.

#### Note:

- **Pay strict attention when wrapping the copper piping since wrapping the piping may cause condensation instead of preventing it.**
- \* Before brazing the refrigerant piping, **always wrap the piping on the main body, and the thermal insulation piping, with damp cloths to prevent heat shrinkage and burning the thermal insulation tubing.** Take care to ensure that the flame does not come into contact with the main body itself.

[Fig. IV. 2. (4). 2]

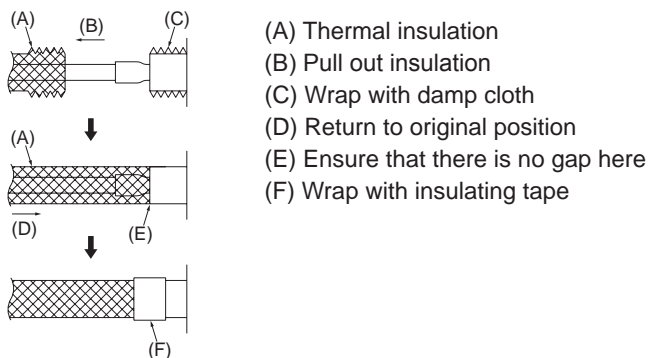

## Cautions On Refrigerant Piping

- Be sure to use non-oxidative brazing for brazing to ensure that no foreign matter or moisture enter into the pipe.
- Be sure to apply refrigerating machine oil over the flare connection seating surface and tighten the connection using a double spanner.
- Provide a metal brace to support the refrigerant pipe so that no load is imparted to the indoor unit end pipe. This metal brace should be provided 50 cm away from the indoor unit's flare connection.

### ⚠ Warning:

When installing and moving the unit, do not charge it with refrigerant other than the refrigerant (R407C or R22) specified on the unit.

- Mixing of a different refrigerant, air, etc. may cause the refrigerant cycle to malfunction and result in severe damage.

### ⚠ Caution:

- Use refrigerant piping made of C1220 (CU-DHP) phosphorus deoxidized copper as specified in the JIS H3300 "Copper and copper alloy seamless pipes and tubes". In addition, be sure that the inner and outer surfaces of the pipes are clean and free of hazardous sulphur, oxides, dust/dirt, shaving particles, oils, moisture, or any other contaminant.
- Never use existing refrigerant piping.
  - The large amount of chlorine in conventional refrigerant and refrigerator oil in the existing piping will cause the new refrigerant to deteriorate.
- Store the piping to be used during installation indoors and keep both ends of the piping sealed until just before brazing.
  - If dust, dirt, or water gets into the refrigerant cycle, the oil will deteriorate and the compressor may fail.

## (4)-2 Drain piping work

1. Ensure that the drain piping is downward (pitch of more than 1/100) to the outdoor (discharge) side. Do not provide any trap or irregularity on the way. (a)
2. Ensure that any cross-wise drain piping is less than 20 m (excluding the difference of elevation). If the drain piping is long, provide metal braces to prevent it from waving. Never provide any air vent pipe. Otherwise drain may be ejected.
3. Use a hard vinyl chloride pipe VP-25 (with an external diameter of 32 mm) for drain piping.
4. Ensure that collected pipes are 10 cm lower than the unit body's drain port as shown in (b).
5. Do not provide any odor trap at the drain discharge port.
6. Put the end of the drain piping in a position where no odor is generated.
7. Do not put the end of the drain piping in any drain where ionic gases are generated.

[Fig. IV. 2. (4).3]

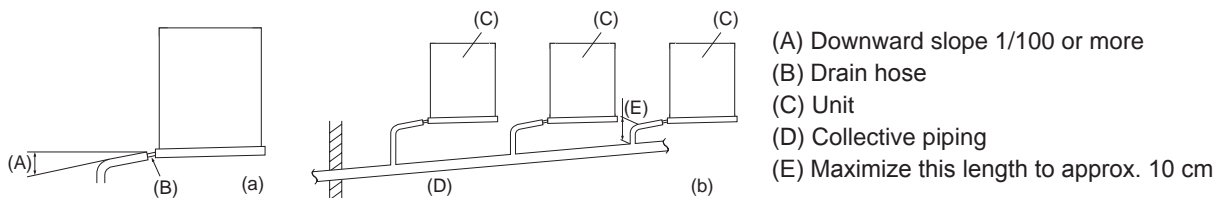

### 3. Water pipe installation

#### (1) Water circuit sample

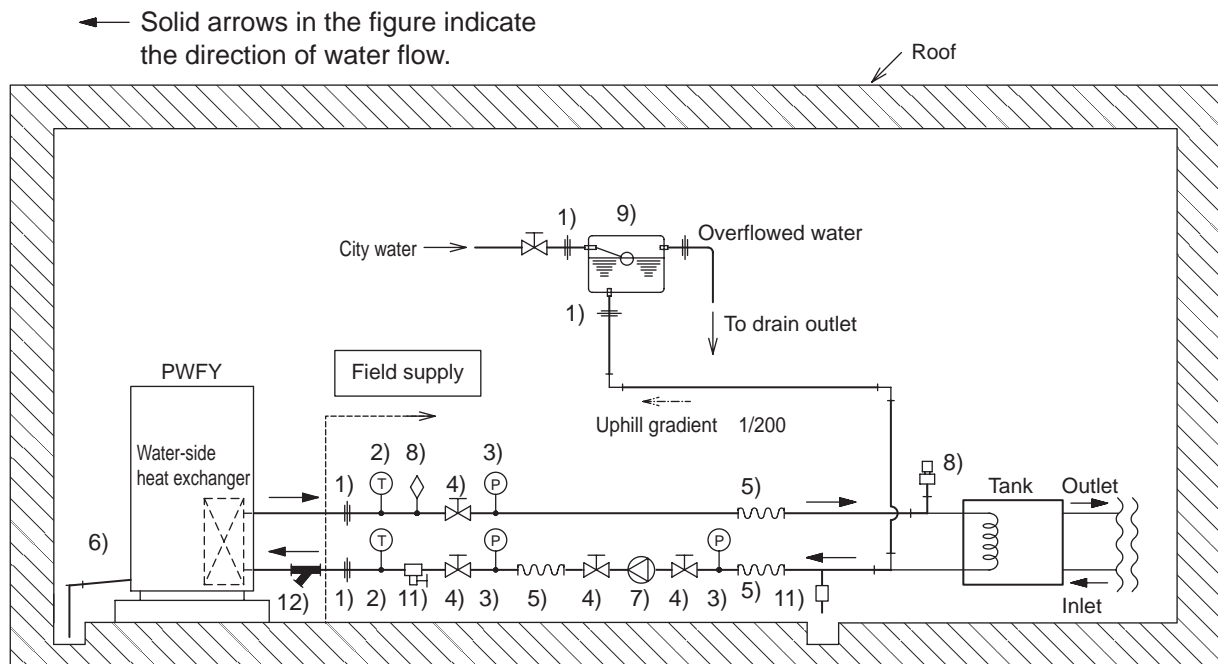

Sample of water circuit for HWS/ATW

Consider the following when designing and installing a water piping system. (Items (1)-(12) in the figure are explained below.)

- 1) Union joints/flange joints etc.  
Install a flange etc. to allow for easy replacement of connected equipment.
- 2) Thermometer  
For checking unit performance and operation monitoring
- 3) Water pressure gauge  
For operation status monitoring
- 4) Valve  
Install a valve for easy replacement and cleaning of the refrigerant flow control device.  
Install a refrigerant flow control valve on the fan coil outlet side.
- 5) Flexible joint  
Recommended to prevent the noise and vibration from the pump from being transmitted.
- 6) Drain pipe  
Install the drain pipe with an inclination of between 1/100 and 1/200 to provide a downward flow of drain water.  
For cold climate installation, take an appropriate measure (e.g., drain heater) to prevent the drain water from freezing.
- 7) Pump  
Use a pump that is large enough to compensate for the total water pressure loss and to supply sufficient water to the unit.
- 8) Air vent valve  
Provide air vent valves on the pipes.
- 9) Expansion tank  
Install an expansion tank to accommodate expanded water and to supply water.
- 10) Cold/Hot water pipe  
Use pipes that allow for easy air purging, and provide sufficient insulation.
- 11) Drain valve  
Install drain valves so that water can be drained for servicing.
- 12) Strainer  
Install a strainer near the PWFY unit to keep foreign materials from entering the water-side heat exchanger.

## (1)-1 Caution for water pipe installation

Consider the following when designing and installing a water piping system.

- Do not use steel pipes as water pipes.
- Copper pipes or stainless steel pipes are recommended. If iron pipes are used in the existing system, do not connect a new circuit to the old one. Keep the existing and new circuits separate.
- Light pipes are similar to other air-conditioning pipes, however, please observe the following precautions during installation.
- Before a long period of non use, purge the water out of the pipes and thoroughly let them dry.
- Use a closed water circuit.
- When using the unit for cooling, add brine to the circulating water to prevent it from freezing.
- When installed in a low-ambient temperature environment, keep the water circulating at all times. If that is not possible, purge the water out of the pipes completely.
- Do not use the water used for this unit for drinking or food manufacturing.
- When the ambient temperature is 0 °C or lower during stop operation, keep the water circulating at all times, or purge the water out of the pipes completely.

Model	Water inlet	Water outlet
PWFY-P100VM-E-BU	PT 3/4 Screw	PT 3/4 Screw
PWFY-P100VM-E-AU	PT 3/4 Screw	PT 3/4 Screw
PWFY-P200VM-E-AU *1 When the attached expansion joints are installed.	PT 1 Screw*1	PT 1 Screw*1

## (2) Selecting a water pump

Use a pump that is large enough to compensate for the total water pressure loss and to supply sufficient water to the unit.

## (3) Installing the strainer

- Install the strainer at the angle of 45° or less as shown in [Fig. IV 3.(3).1].
- Install the supplied strainer at the water inlet.

[Fig. IV 3.(3).1]

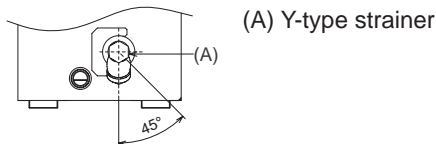

## (4) Precautions during installation

- Use the reverse-return method to insure proper pipe resistance to each unit.
- To insure easy maintenance, inspection, and replacement of the unit, use a proper joint, valve, etc. on the water intake and outlet port. In addition, be sure to install a strainer on the water intake pipe. (In order to maintain the heat source unit, a strainer on the circulating water inlet is necessary.)
- \* An example of the heat source unit installation is shown in the diagram below.
- Install a suitable air vent on the water pipe. After sending water through the pipe, be sure to vent the excess air.
- Compressed water may form in the low-temperature sections of heat source unit. Use a drainage pipe connected to the drain valve at the base of the unit to drain the water.
- Install a back flow-prevention valve on the pump and a flexible joint to prevent excess vibration.
- Use a sleeve to protect the pipes where they go through a wall.
- Use metal fittings to secure the pipes, and install them so that they have maximum protection against breakage and bending.
- Do not confuse the water intake and outlet valves.
- This unit doesn't have any heater to prevent freezing within tubes. When the water flow is stopped on low ambient, take out the water from tubes.
- The unused knockout holes should be closed and the opening of refrigerant pipes, water pipes, power source and transmission wires should be filled with putty and so on to prevent from rain. (field construction)
- Wrap some sealing tape around the screw part to prevent water leakage.
- Hold the pipe on the unit side in place with a spanner when installing the pipes or strainer. Tighten screws to a torque of 50 N·m.
- Water pipes can get very hot, depending on the preset temperature. Wrap the water pipes with insulating materials to prevent burns.
- On the PWFY-P200VM-E-AU model, install the expansion joint (accessory) at the inlet after installing the strainer, and outlet.

## (5) Example of unit installation (using light piping)

[Fig. IV. 3.(5).1]

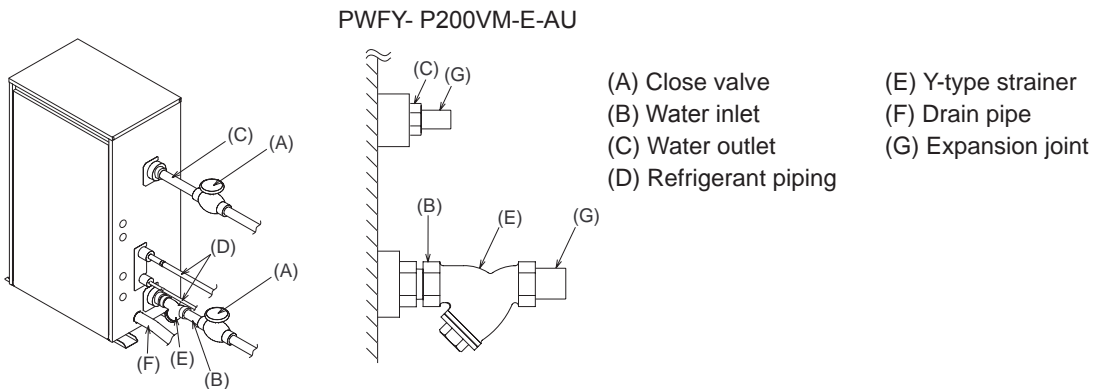

## (6) Insulation installation

The surface temperature of the water pipe would be very high, depending on the set temperature. Insulate the pipe to prevent burns. When operating PWFY-P100, P200VM-E-AU with cold water, insulate the water pipe to prevent condensation.

Wrap insulation material around water pipes as shown in [Fig. IV. 3.(6).1].

- Any heat source piping.
- Indoor piping in cold-weather regions where frozen pipes are a problem.
- When air coming from the outside causes condensation to form on piping.
- Any drainage piping.

[Fig. IV. 3.(6).1]

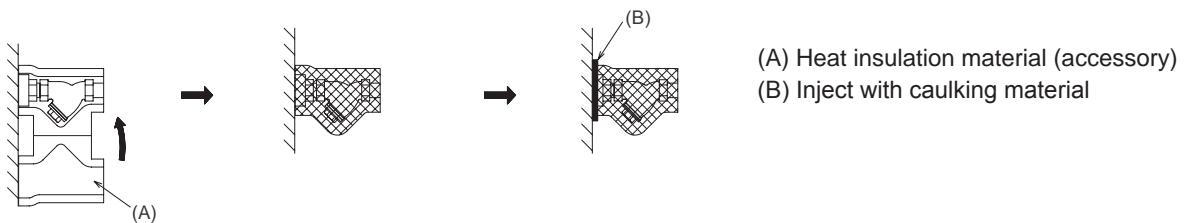

## (7) Water processing and water quality control

To preserve water quality, use the closed type of cooling tower for unit. When the circulating water quality is poor, the water heat exchanger can develop scales, leading to a reduction in heat-exchange power and possible corrosion of the heat exchanger. Please pay careful attention to water processing and water quality control when installing the water circulation system.

- Removal of foreign objects or impurities within the pipes.  
During installation, be careful that foreign objects, such as welding fragments, sealant particles, or rust, do not enter the pipes.
- Water Quality Processing
  - a) Depending on the quality of the cold-temperature water used in the air-conditioner, the copper piping of the heat exchanger may become corroded. We recommend regular water quality processing.  
Cold water circulation systems using open heat storage tanks are particularly prone to corrosion.  
When using an open-type heat storage tank, install a water-to-water heat exchanger, and use a closed-loop circuit on the air conditioner side. If a water supply tank is installed, keep contact with air to a minimum, and keep the level of dissolved oxygen in the water no higher than 1mg/liter.
  - b) Water quality standard

Items		Lower mid-range temperature water system Water Temp. <= 60 °C		Higher mid-range temperature water system Water Temp. > 60 °C		Tendency	
		Recirculating water	Make-up water	Recirculating water	Make-up water	Corrosive	Scale-forming
Standard items	pH (25 °C)	7.0 ~ 8.0	7.0 ~ 8.0	7.0 ~ 8.0	7.0 ~ 8.0	○	○
	Electric conductivity(mS/m) (25 °C) (μ s/cm) (25 °C)	30 or less [300 or less]	30 or less [300 or less]	30 or less [300 or less]	30 or less [300 or less]	○	○
	Chloride ion (mg Cl/liter)	50 or less	50 or less	30 or less	30 or less	○	
	Sulfate ion (mg SO <sub>4</sub> <sup>2-</sup> /liter)	50 or less	50 or less	30 or less	30 or less	○	
	Acid consumption (pH4.8) (mg CaCO <sub>3</sub> /liter)	50 or less	50 or less	50 or less	50 or less		○
	Total hardness (mg CaCO <sub>3</sub> /liter)	70 or less	70 or less	70 or less	70 or less		○
	Calcium hardness (mg CaCO <sub>3</sub> /liter)	50 or less	50 or less	50 or less	50 or less		○
	Ionic silica (mg SiO <sub>2</sub> /liter)	30 or less	30 or less	30 or less	30 or less		○
Reference items	Iron (mg Fe/liter)	1.0 or less	0.3 or less	1.0 or less	0.3 or less	○	○
	Copper (mg Cu/liter)	1.0 or less	1.0 or less	1.0 or less	1.0 or less	○	
	Sulfide ion (mg S <sup>2-</sup> /liter)	not to be detected	not to be detected	not to be detected	not to be detected	○	
	Ammonium ion (mg NH <sub>4</sub> <sup>+</sup> /liter)	0.3 or less	0.1 or less	0.1 or less	0.1 or less	○	
	Residual chlorine (mg Cl/liter)	0.25 or less	0.3 or less	0.1 or less	0.3 or less	○	
	Free carbon dioxide (mg CO <sub>2</sub> /liter)	0.4 or less	4.0 or less	0.4 or less	4.0 or less	○	
	Ryzner stability index	-	-	-	-	○	○

Reference : Guideline of Water Quality for Refrigeration and Air Conditioning Equipment. (JRA GL02E-1994)

- c) Please consult with a water quality control specialist about water quality control methods and water quality calculations before using anti-corrosive solutions for water quality management.
- d) When replacing a previously installed air conditioning device (even when only the heat exchanger is being replaced), first conduct a water quality analysis and check for possible corrosion.  
Corrosion can occur in cold-water systems even if there has been no prior signs of corrosion.  
If the water quality level has dropped, please adjust water quality sufficiently before replacing the unit.  
The maximum amount of circulating water in the water pipe is 100L. Make sure that this amount is not exceeded.

## (8) Pump interlock

The unit may become damaged if it is operated with no water circulating through the pipes.

Be sure to interlock unit operation and the water-circuit pump. Use the terminal blocks for interlocking TB142A (IN1) that can be found on the unit.

[Fig. IV. 3. (8).1]

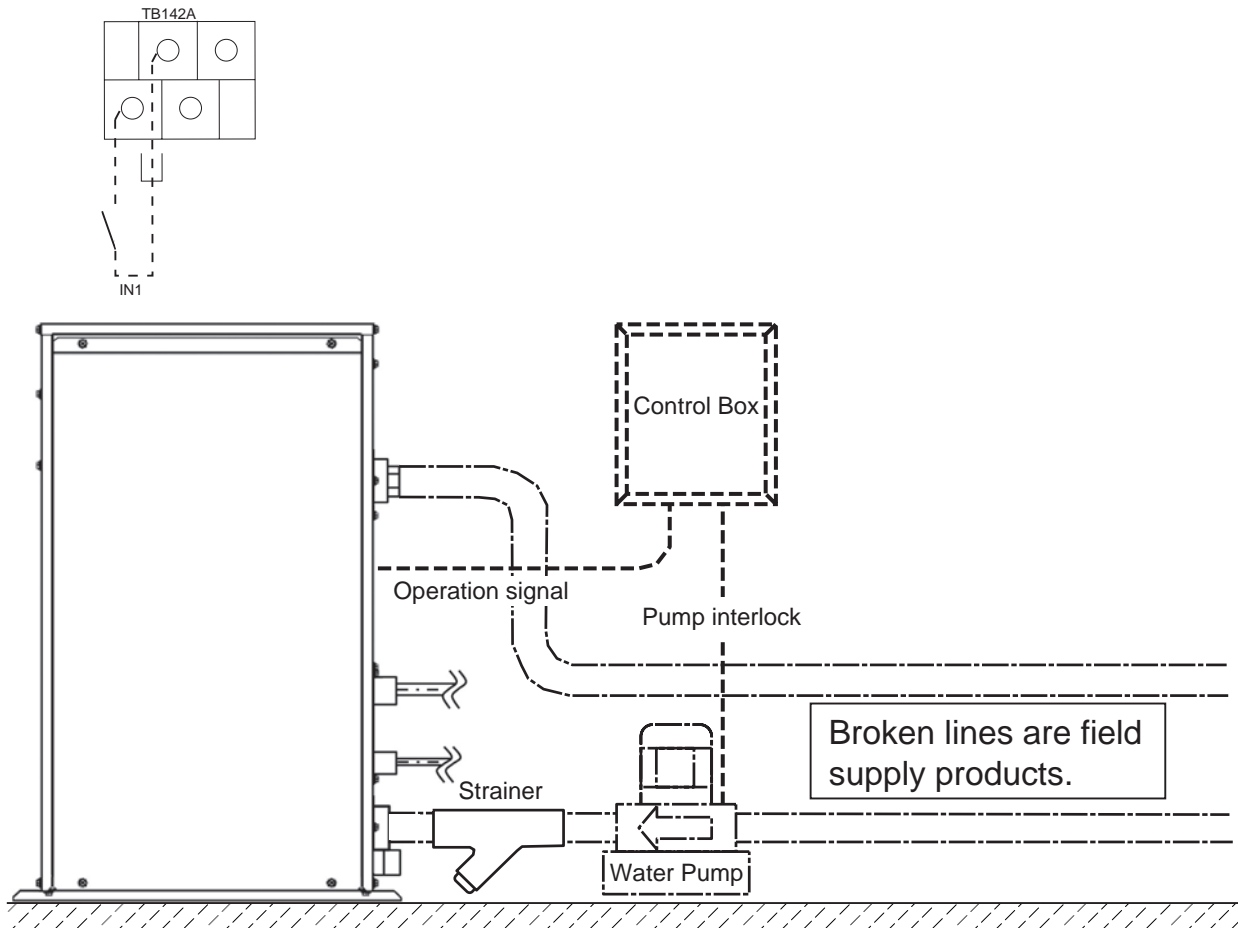

Example drawing for pump interlock



# V System Design

## 1. Electrical work

### (1) General cautions

**⚠ Warning:**

Electrical work should be done by qualified electrical engineers in accordance with “Engineering Standards For Electrical Installation” and supplied installation manuals. Special circuits should also be used. If the power circuit lacks capacity or has an installation failure, it may cause a risk of electric shock or fire.

1. Be sure to take power from the special branch circuit.
2. Be sure to install an earth leakage breaker to the power.
3. Install the unit to prevent that any of the control circuit cables (remote controller, transmission cables, or external input/output line) is brought in direct contact with the power cable outside the unit.
4. Ensure that there is no slack on all wire connections.
5. Some cables (power, remote controller, transmission cables external input/output line) above the ceiling may be bitten by mouses. Use as many metal pipes as possible to insert the cables into them for protection.
6. Never connect the power cable to leads for the transmission cables. Otherwise the cables would be broken.
7. Be sure to connect control cables to the indoor unit, remote controller, and the outdoor unit.
8. Be sure to ground the unit.
9. Select control cables from the conditions given in page 42.

**⚠ Caution:**

Be sure to put the unit to the ground on the outdoor unit side. Do not connect the earth cable to any gas pipe, water pipe, lightning rod, or telephone earth cable. Incomplete grounding may cause a risk of electric shock.

### (2) Power supply for PWFY unit

#### (2)-1 Electrical characteristics of PWFY unit

- Power supply cords of appliances shall not be lighter than design 245 IEC 57 or 227 IEC 57.
- A switch with at least 3 mm contact separation in each pole shall be provided by the Air conditioner installation.

Model	Power supply				Compressor		RLA (A)
	Hz	Volts	Voltage range	MCA (A)	Output (kW)	SC (A)	Heating
PWFY-P100VM-E-BU	50/60	220-230-240 V	Max. 264 V Min. 198 V	15.71	1.0	1.25	11.63-11.12-10.66

Model	Power supply				RLA (A)	
	Hz	Volts	Voltage range	MCA (A)	Cooling	Heating
PWFY-P100VM-E-AU PWFY-P200VM-E-AU	50/60	220-230-240 V	Max. 264 V Min. 198 V	0.085	0.068-0.065-0.063	

#### (2)-2 Power cable specifications

Model	Minimum wire thickness (mm <sup>2</sup> )			Breaker for current leakage	Local switch (A)		Breaker for wiring (NFB) (A)
	Main cable	branch	Ground		capacity	fuse	
PWFY-P100VM-E-BU	2.5	-	2.5	30 A 30 mA 0.1 sec or less	25	25	30

Model	Total operating current	Minimum wire thickness (mm <sup>2</sup> )			Breaker for current leakage	Local switch (A)		Breaker for wiring (NFB) (A)
		Main cable	branch	Ground		capacity	fuse	
PWFY-P100VM-E-AU PWFY-P200VM-E-AU	16 A or less	1.5	1.5	1.5	20 A 30 mA 0.1 sec. or less	16	16	20
	25 A or less	2.5	2.5	2.5	30 A 30 mA 0.1 sec. or less	25	25	30
	32 A or less	4.0	4.0	4.0	40 A 30 mA 0.1 sec. or less	32	32	40

[Fig. V. 1.(2).1]

PWFY-P100VM-E-BU

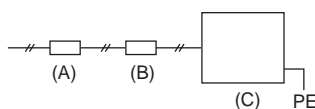

PWFY-P100,200VM-E-AU

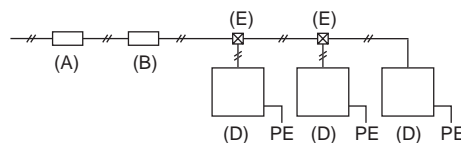

- (A) Breaker for current leakage
- (B) Local switch or breakers for wiring
- (C) PWFY-P100VM-E-BU
- (D) PWFY-P100, 200VM-E-AU
- (E) Pull box

**⚠ Caution:**

Do not use anything other than the correct capacity breaker and fuse. Using fuse, wire or copper wire with too large capacity may cause a risk of malfunction or fire.

### (3) Connecting remote controller, indoor and outdoor transmission cables

- Connect unit TB5 and outdoor unit TB3. (Non-polarized 2-wire (shield))  
The “S” on unit TB5 is a shielding wire connection. For specifications about the connecting cables, refer to the outdoor unit installation manual.
- Install a remote controller following the manual supplied with the remote controller.

#### (3)-1 Power supply examples

##### (3)-1-1 Using MA Remote controller (Remote controller is optionally available)

- Connect the “1” and “2” on unit TB15 to a MA remote controller. (Non-polarized 2-wire)  
[Fig. V. 1. (3). 1] MA Remote controller

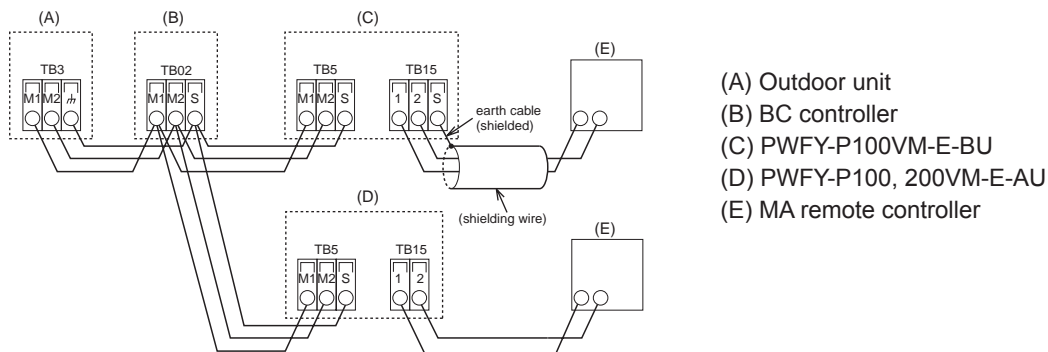

- DC 10 to 13 V between 1 and 2 (MA remote controller)  
[Fig. V. 1. (3). 2] MA Remote controller

PWFY- P100VM-E-BU

PWFY- P100, 200VM-E-AU

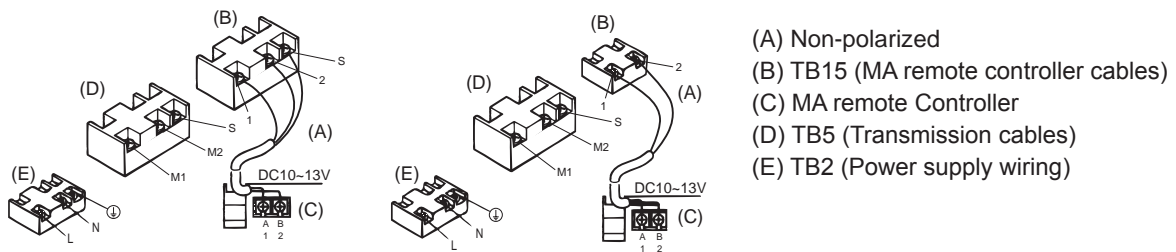

- The MA remote controller cannot be used at the same time or interchangeably.

#### Note:

Ensure that the wiring is not pinched when fitting the terminal box cover. Pinching the wiring may cut it.

#### ⚠ Caution:

- Use wire with supplemental insulation.
- Input to TB142A, TB142B, and TB142C should not carry voltage.
- Cables from equipment connected to external input/output should have supplemental insulation.
- Use a single multiple-core cable for external input/output to allow for connection to the PG screw.

#### ⚠ Caution:

Wire the power supply so that no tension is imparted. Otherwise disconnection, heating or fire result.

## (4) Transmission cable specifications

### (4)-1 Transmission cables

PWFY-P100VM-E-BU

	Transmission cables	MA Remote controller cables	External input	External output
Type of cable	Shielding wire (2-core) CVVS, CPEVS or MVVS	Sheathed 2-core cable (shielded) CVVS	Sheathed multi-core cable (shielded) CVVS or MVVS	Sheathed multi-core cable (unshielded) CVV or MVV
Cable diameter	More than 1.25 mm <sup>2</sup>	0.3 ~ 1.25 mm <sup>2</sup> (0.75 ~ 1.25 mm <sup>2</sup> )*1	0.3 ~ 0.5 mm <sup>2</sup>	0.3 ~ 1.25 mm <sup>2</sup>
Remarks	-	Max.length: 200 m	Max.length: 100 m	Rated voltage: L1-N: 220 ~ 240 V Rated load: 0.6 A

PWFY-P100, 200VM-E-AU

	Transmission cables	MA Remote controller cables	External input	External output
Type of cable	Shielding wire (2-core) CVVS, CPEVS or MVVS	Sheathed 2-core cable CVV (unshielded)	Sheathed multi-core cable CVV or MVV (unshielded)	Sheathed multi-core cable (unshielded) CVV or MVV
Cable diameter	More than 1.25 mm <sup>2</sup>	0.3 ~ 1.25 mm <sup>2</sup> (0.75 ~ 1.25 mm <sup>2</sup> )*1	0.3 ~ 0.5 mm <sup>2</sup>	0.3 ~ 1.25 mm <sup>2</sup>
Remarks	-	Max.length: 200 m	Max.length: 100 m	Rated voltage: L1-N: 220 ~ 240 V Rated load: 0.6 A

\*1 Connected with simple remote controller. CVVS, MVVS: PVC insulated PVC jacketed shielded control cable  
CVV, MVV : PVC insulated PVC sheathed control cable  
CPEVS : PE insulated PVC jacketed shielded communication cable

## (5) Connecting electrical connections

Verify that the model name on the operating instructions on the cover of the control box is the same as the model name on the nameplate.

### Step 1

Remove the screws holding the terminal box cover in place.

[Fig. V.1.(5).1]

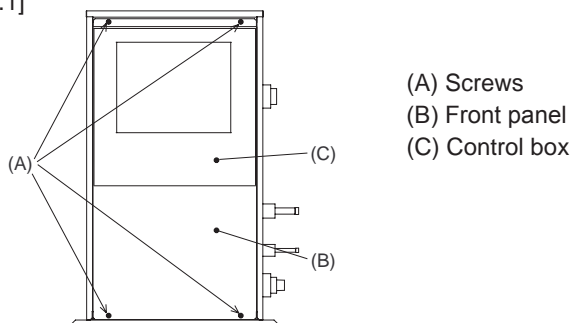

### Note:

Ensure that the wiring is not pinched when fitting the terminal box cover. Pinching the wiring may cut it.

### ⚠ Caution:

Install wiring so that it is not tight and under tension. Wiring under tension may break, or overheat and burn.

- Fix power source external input/output line wiring to control box by using buffer bushing for tensile force to prevent electric shock. (PG connection or the like.) Connect transmission wiring to transmission terminal block through the knockout hole of control box using ordinary bushing.
- After wiring is complete, make sure again that there is no slack on the connections, and attach the cover onto the control box in the reverse order removal.

[Fig. IV. 1.(5).2]

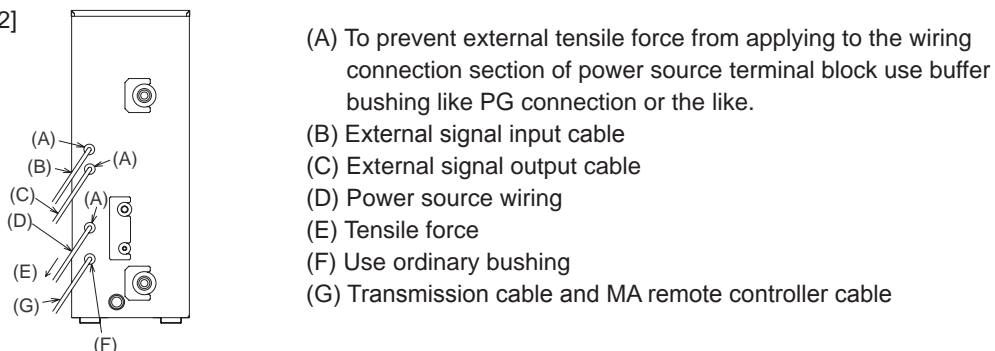

### ⚠ Caution:

Wire the power supply so that no tension is imparted. Otherwise disconnection, heating or fire result.

---

## (6) Address setting

### (6)-1 Switch operation

(Be sure to operate with the main power turned OFF.)





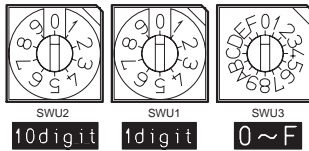



















[Fig. V. 1.(6).1]

<Address board>



- There are two types of rotary switch setting available: setting addresses 1 to 9 and over 10, and setting branch numbers.
  - a) How to set addresses  
Example: If Address is "3", remain SWU2 (for over 10) at "0", and match SWU1 (for 1 to 9) with "3".
  - b) How to set branch numbers SWU3 (Series R2 only)  
Match the indoor unit's refrigerant pipe with the BC controller's end connection number. Remain other than R2 at "0".
- The rotary switches are all set to "0" when shipped from the factory. These switches can be used to set unit addresses and branch numbers at will.

## (6)-2 Rule of setting address

Unit	Address setting	Example	Note	
PWFY unit Standard indoor unit	01 ~ 50	  10      1	Use the most recent address within the same group of indoor units. Make the indoor units address connected to the BC controller (Sub) larger than the indoor units address connected to the BC controller (Main). If applicable, set the sub BC controllers in an PURY system in the following order: (1) Indoor unit to be connected to the BC controller (Main) (2) Indoor unit to be connected to the BC controller (No.1 Sub) (3) Indoor unit to be connected to the BC controller (No.2 Sub) Set the address so that (1)<(2)<(3)	
Outdoor unit	51 ~ 99, 100 (Note1)	  10      1	The smallest address of indoor unit in same refrigerant system + 50 Assign sequential address numbers to the outdoor units in one refrigerant circuit system. OC and OS are automatically detected. (Note 2) * Please reset one of them to an address between 51 and 99 when two addresses overlap. * The address automatically becomes "100" if it is set as "01~ 50"	
BC controller (Main)	52 ~ 99, 100	  10      1	The address of outdoor unit + 1 * Please reset one of them to an address between 52 and 99 when two addresses overlap. *The address automatically becomes "100" if it is set as "01~ 50"	
BC controller (Sub)	53 ~ 99, 100	  10      1	Lowest address within the indoor units connected to the BC controller (Sub) plus 50.	
Local remote controller	ME, LOSSNAY Remote controller (Main)	101 ~ 150 <b>1</b> Fixed	  10      1	The smallest address of indoor unit in the group + 100 * The place of "100" is fixed to "1"
	ME, LOSSNAY Remote controller (Sub)	151 ~ 199, 200 <b>1</b> Fixed	  10      1	The address of main remote controller + 50 *The address automatically becomes "200" if it is set as "00"
System controller	Group remote controller	201 ~ 250 <b>2</b> Fixed	  10      1	The smallest group No. to be managed + 200
	System remote controller	000, 201 ~ 250	   100      10      1	
	ON/OFF remote controller	000, 201 ~ 250	   100      10      1	
	G-50A GB-50A AG-150A	000, 201 ~ 250	   100      10      1	
	LMAP02-E	201 ~ 250 <b>2</b> Fixed	  10      1	

Note1: To set the address to "100", set it to "50"

Note2: Outdoor units OC and OS in one refrigerant circuit system are automatically detected.

OC and OS are ranked in descending order of capacity. If units are the same capacity, they are ranked in ascending order of their address.

## (6)-3 System examples

(6)-3-1 MA remote controller, Multi-refrigerant-system, System Controller at TB7 side, Booster for long M-NET wiring

### PWFY-P100VM-E-BU/PWFY-P100, 200VM-E-AU with R2 series outdoor units

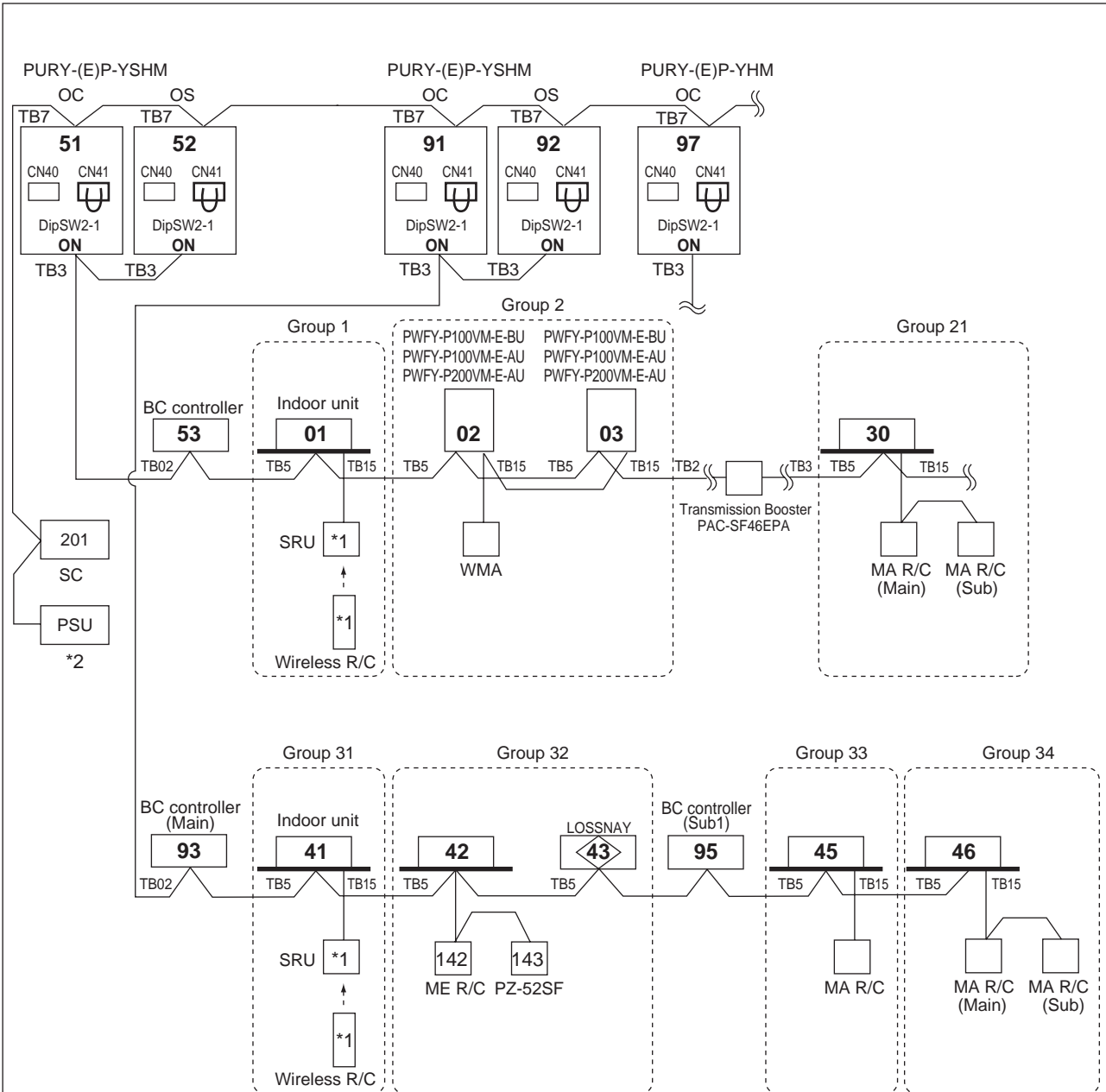

\*1 For Wireless R/C and Signal receiver unit (SRU), channel 1, 2 and 3 are selectable and should be set to same channel.

\*2 System controller should connect to TB7 at Outdoor and use power supply unit together in Multi-Refrigerant-System.

#### NOTE:

- Outdoor units OC and OS in one refrigerant circuit system are automatically detected. OC and OS are ranked in descending order of capacity. If units are the same capacity, they are ranked in ascending order of their address.
- Address should be set to Indoor units, LOSSNAY and central controller.
- M-NET power is supplied by the Outdoor unit at TB3, while Indoor unit and MA RC consume the M-NET power for transmission use. The power balance is needed to consider for long M-NET wiring. Details refer to Data book G4 2-3 "System configuration restrictions".
- Indoor units should be set with a branch number.
- Assign an address to each of the sub BC controllers (SC1 and SC2) which equals the sum of the smallest address of the indoor units that are connected to each sub BC controller and 50.

**PWFY-P100, 200VM-E-AU with Y series outdoor units**

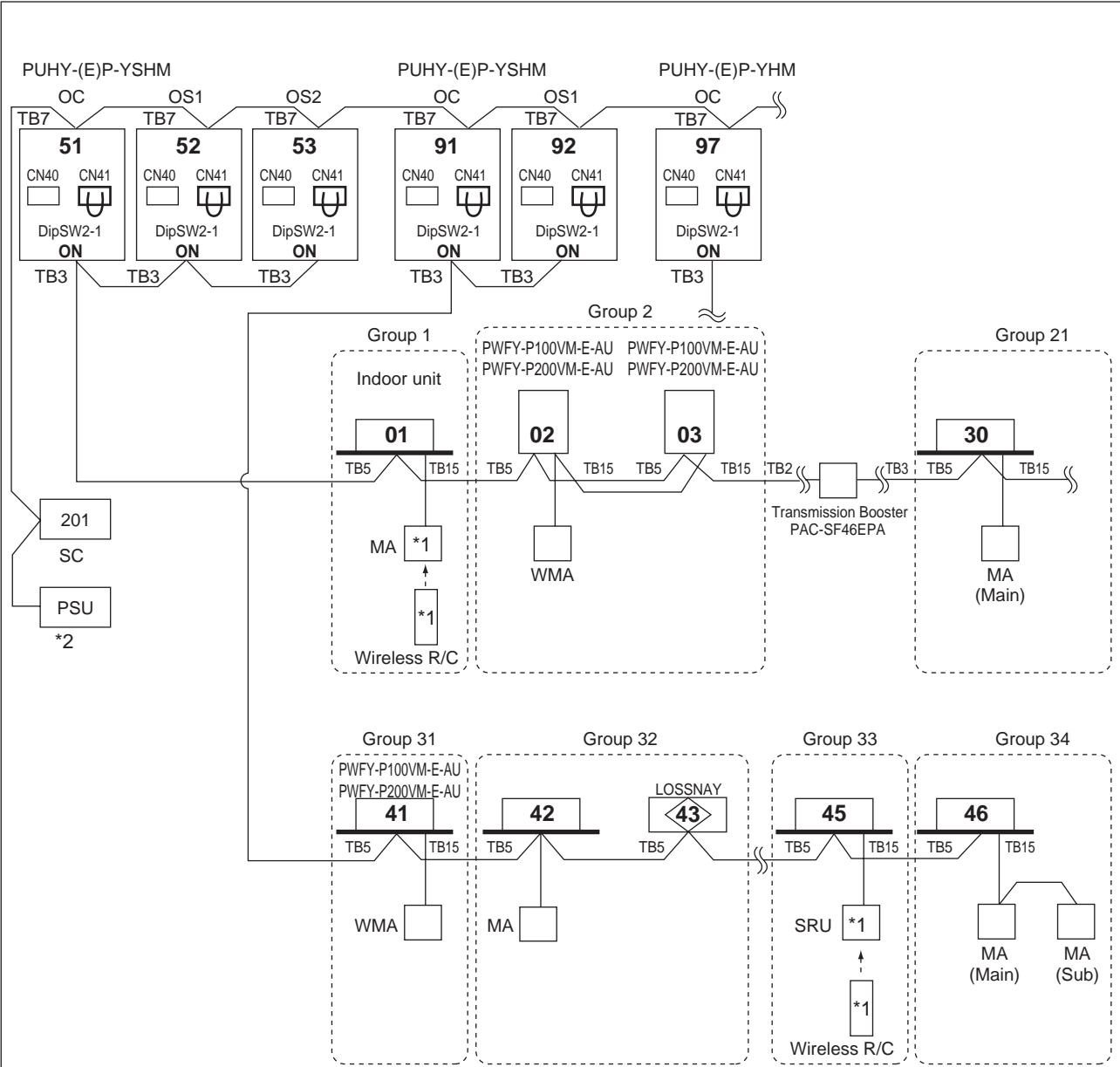

\*1 For Wireless R/C and Signal receiver unit (SRU), channel 1, 2 and 3 are selectable and should be set to same channel.

\*2 System controller should connect to TB7 at Outdoor and use power supply unit together in Multi-Refrigerant-System.

**NOTE:**

1. Outdoor units OC, OS1 and OS2 in one refrigerant circuit system are automatically detected. OC, OS1 and OS2 are ranked in descending order of capacity. If units are the same capacity, they are ranked in ascending order of their address.
2. Address should be set to Indoor units, LOSSNAY and central controller.
3. M-NET power is supplied by the Outdoor unit at TB3, while Indoor unit and MA consume the M-NET power for transmission use. The power balance is needed to consider for long M-NET wiring. Details refer to Data book G4 2-3 "**System configuration restrictions**".

## (7) External input/output function

### Preset temperature input (external analog input: 4mA-20mA)

External input is input through CN421, CN422 on the circuit board. (Fig. V. 1.(7).1)

[Fig. V. 1.(7).1]

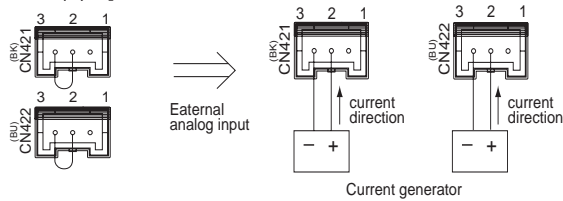

Use the supplied connector.

If no temperature settings are made via the MA remote controller, the temperature changes with the current of generator. Refer to the instructions manual that came with the MA remote controller for how to make the settings.

4 mA → 10 °C    20 mA → 70 °C

### External output terminal

External output terminal (refer to Fig. V. 1.(7).2) is ineffective when the circuit is open.

Refer to Table V. 1.(7).1 for information about each contact.

The current in the circuit to be connected to the external output terminal must be 0.6A or less.

Table V. 1.(7).1

OUT1	Operation ON/OFF
OUT2	Defrost
OUT3	Compressor
OUT4	Error signal

[Fig. V. 1.(7).2]

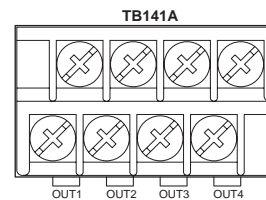

### External input terminal

The piping length must be within 100 m.

External input terminal (refer to Fig. V. 1.(7).2) is ineffective when the circuit is open.

Refer to Table V. 1.(7).2 through Table V. 1.(7).4 for information about each contact.

Only the "pump interlock" function is ineffective when the circuit is short-circuited.

Connect a relay circuit to the external output terminal as shown in Fig. V. 3.(8).1.

The specifications of the relay circuit to be connected must meet the following conditions.

Contact rating voltage  $\geq$  DC15V

Contact rating current  $\geq$  0.1A

Minimum applicable load  $\leq$  1mA at DC

[Table V. 1.(7).2] TB142A

IN1	Pump interlock
-----	----------------

[Table V. 1.(7).3] TB142B

IN3	Connection demand
IN4	Operation ON/OFF

[Table V. 1.(7).4] TB142C

COM+	Common
IN5 *1	Hot Water/Heating
IN6 *2	Heating ECO *4
IN7 *3	Anti-freeze *5

[Fig. V. 1.(7).3]

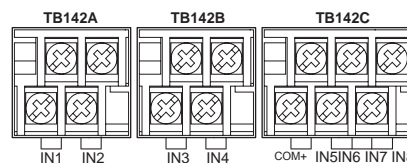

\*1 PWFY-P100VM-E-BU            Hot Water  
PWFY-P100, 200VM-E-AU    Heating

\*2 Effective when SW 4-3 is set to ON.

\*3 Effective when SW 4-4 is set to ON.

\*4 When Heating ECO mode is effective, the outlet water temp. will be changed based on ambient temp. automatically.

\*5 When Anti-freeze mode is effective, the unit will work for keeping set water temp. automatically.

### Note:

**Dip S/W 1-1 OFF: Water Inlet Temp.**

**Dip S/W 1-1 ON : Water Outlet Temp.**

**The factory setting for Dip SW 1-1 is OFF.**

Signal priority = External input > centralized controller > remote controller



# VI Control

## 1. Dip switch functions

Switch	Function	Function according to switch setting		Switch setting timing	
		OFF	ON		
SW1	1	TH0 thermistor selection	Water inlet thermistor TH6	Water outlet thermistor TH8	Before power on
	2	-	-	-	-
	3	Operation after power recovery *1	Remains stopped	Auto recovery (to the status before power failure)	Before power on
	4	Operation after power recovery	Depends on the SW1-3 setting	Forced to operate	Before power on
	5	-	-	-	-
	6	-	-	-	-
	7	Test-run mode	OFF	ON	Any time
	8	Error history deleted	Normal	Deleted	Any time
	9	Effective only when SW1-7 is set to ON and only on the ATW models.	Heating	Cooling	Any time
	10	-	-	-	-
SW2	1-10	For self-diagnosis/operation monitoring	-	-	Any time
SW3	1	Capacity setting (ATW only)	4HP	8HP (ATW only)	Before power on
	2	Service LED display selection	Display in Centigrade	Display in Fahrenheit	Any time
	3	-	-	-	-
	4	-	-	-	-
	5	Cumulative compressor operation time is deleted.	Normal	Deleted	Any time
	6	-	-	-	-
	7	-	-	-	-
	8	-	-	-	-
	9	-	-	-	-
	10	-	-	-	-
SW4	1	Do not change from factory setting.			
	2	Do not change from factory setting.			
	3	Use to change preset temperature range for the Heating ECO mode.	HWS : Ineffective ATW : Ineffective	HWS : 30°C to 50°C ATW : 30°C to 50°C	Before power on
	4	Use to change preset temperature range for the Anti-freeze mode.	BU : Ineffective WH : Ineffective	BU : 10°C to 45°C WH : 10°C to 45°C	Before power on
	5	-	-	-	-
	6	-	-	-	-
	7	-	-	-	-
	8	-	-	-	-
	9	-	-	-	-
	10	-	-	-	-
SW5	1	Enabling/disabling ACCT sensor error detection	Error detection enabled	Error detection disable (No load operation is possible)	Any time
	2	-	-	-	-
	3	-	-	-	-
	4	-	-	-	-

\*1 Valid only when SW1-4 is set to OFF

## 2. Remote controller specifications

Item	Description	Operations	Display
ON/OFF	Runs and stops the operation of a group of units	○	○
Operation mode switching	Switches between Hot Water / Heating / Heating ECO / Anti-freeze / Cooling * Available operation modes vary depending on the unit to be connected. * Switching limit setting can be made via a remote controller.	○	○
Water temperature setting	Temperature can be set within the ranges below. (in increments of 1°C or 1°F) Hot Water } 35°C min. ~ 70°C max. (in increments of 1°C or 2°F) Heating } 30°C min. ~ 45°C max. (in increments of 1°C or 2°F) Anti-freeze 10°C min. ~ 45°C max. (in increments of 1°C or 1°F) Cooling 10°C min. ~ 30°C max. (in increments of 1°C or 1°F) * The settable range varies depending on the unit to be connected.	○	○
Preset temperature range	Preset temperature range setting can be limited via a remote controller.	○	○
Water temperature display	10°C min. ~ 90°C max. (in increments of 1°C or 1°F) * The settable range varies depending on the unit to be connected.	×	○
Permit / Prohibit local operation	Individually prohibits operations of each local remote control function :ON/OFF, Operation modes,water temperature setting, Circulating water replacement warning reset. * Upper level controller may not be connected depending on the unit to be connected.	×	○
Weekly scheduler	ON / OFF / Water temperature setting can be done up to 6 times one day in the week. (in increments of a minute)	○	○
Error	When an error is currently occurring on a unit, the afflicted unit and the error code are displayed.	×	○
Self check (Error history)	Searches the latest error history by pressing the CHECK button twice.	○	○
Test run	Enables the Test run mode by pressing the TEST button twice. * Test run mode is not available depending on the unit to be connected.	○	○
Circulating water replacement warning	Displays the circulating water replacement warning via the unit message. Clears the display by pressing the CIR.WATER button twice. * Circulating water replacement warning is not available depending on the unit to be connected.	○	○
LANGUAGE setting	The language on the dot matrix LCD can be changed. (Seven languages) English/German/Spanish/Russian/Italian/French/Swedish	○	○
Operation locking function	Remote controller operation can be locked or unlocked. ·All-switch locking ·Locking except ON/OFF switch	○	○

# VII Maintenance Cycle

## 1. Routine maintenance checks

- Periodically and thoroughly check the circulating water circuit. (See table below.)
- Consult a maintenance technician.

## 2. Parts Replacement Cycle

Regular preventive maintenance and parts replacement help keep the unit running smoothly and minimize problems. The table below shows the maintenance schedule. Use the replacement timing in the table only as a guide. Some parts may need to be replaced sooner, depending on the usage.

Components		What to look for	Maintenance cycle (times/year)	Replacement cycle
Refrigerant circuit components	Compressor	High/low pressure, vibration, noise Insulation resistance, loose terminals	2	20,000 hours
	Water-refrigerant heat exchanger	High/low pressure, water pressure loss	2	10 Years
	Solenoid valve (PWFY-P100, 200VM-E-AU)	Operation, leakage, clogging	2	7 Years
	Check valve (PWFY-P100, 200VM-E-AU)	Operation, leakage, clogging	1	10 Years
	Linear expansion valve	Operation	2	7 Years
	Strainer	Inlet/outlet temperature difference	1	While in heavy use
	Capillary tube	Contact wear, Vibration	1	10 Years
	Pipes	Contact wear, Vibration	1	10 Years
Electric circuit parts	Electromagnetic contactor	Corroded contact, loose terminals Insulation resistance	2	8 Years
	Overcurrent relay	loose terminals	2	7 to 10Years
	Relay	Operation, Contact resistance. Insulation resistance	2	6 Years
	Solenoid valve	Insulation resistance	2	7 Years
	Fuse	External appearance	2	8 Years
	Electronic board	External appearance	2	8 Years
	Switch	Operation, Contact resistance.	2	8 Years
	Pressure switch	Contact resistance.	2	7 to 10Years
	Terminal block	loose terminals	2	8 Years
	Cable/connector	Looseness, corrosion, and wearing	2	10 Years
	Fan	Balance	2	10 Years
Motor	Insulation resistance, noise, vibration	2	6 to 10Years	

# VIII Product Data (supplemental information for chapter III.)

## 1. Capacity tables

(1) Correction by total indoor

(1)-1 Y series

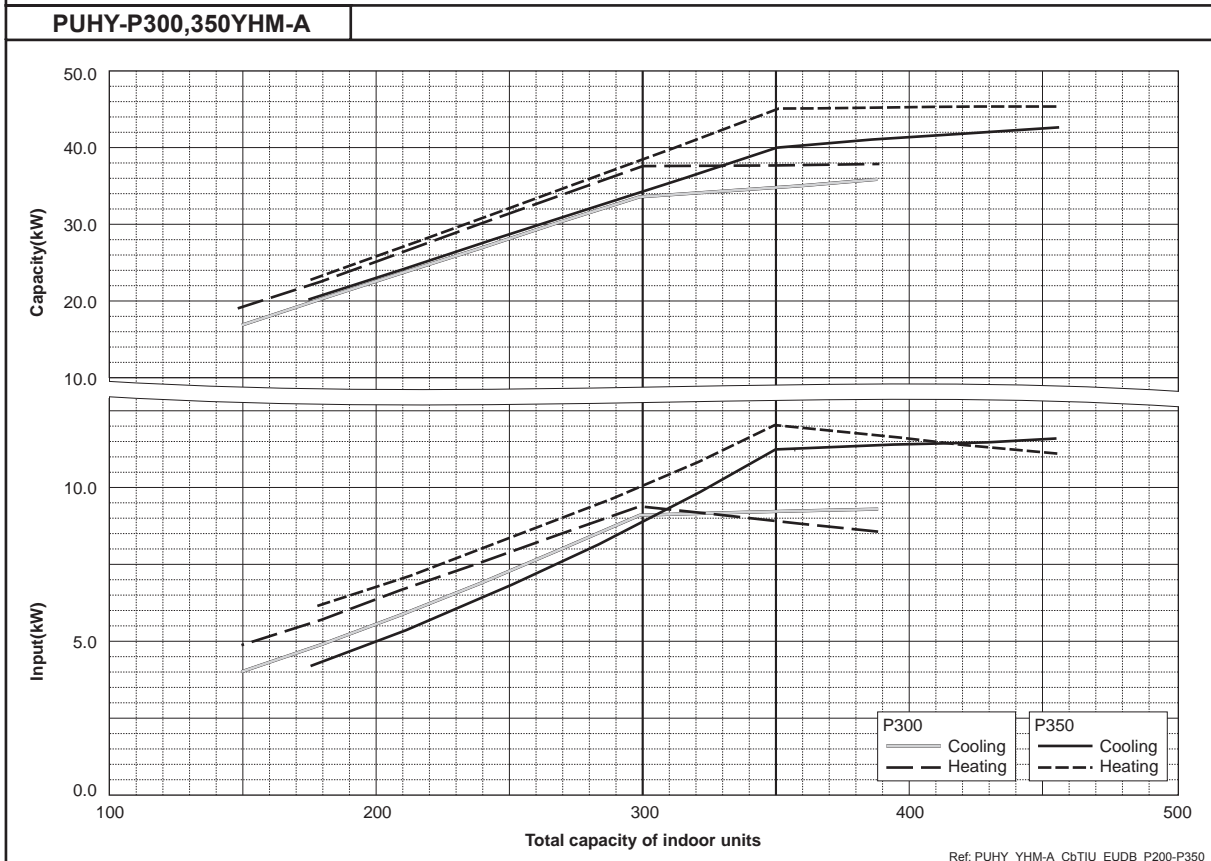
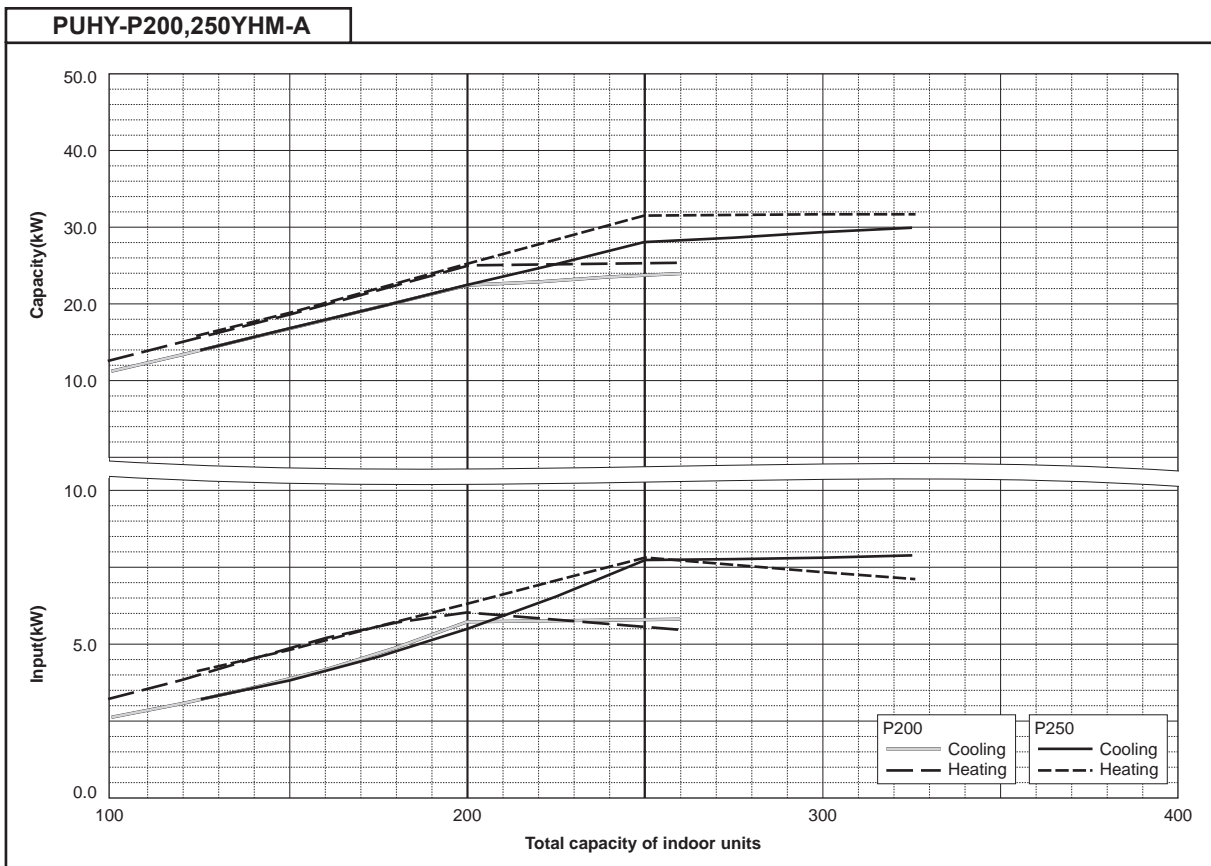

Ref: PUHY\_YHM-A\_CbTIU\_EUDB\_P200-P350

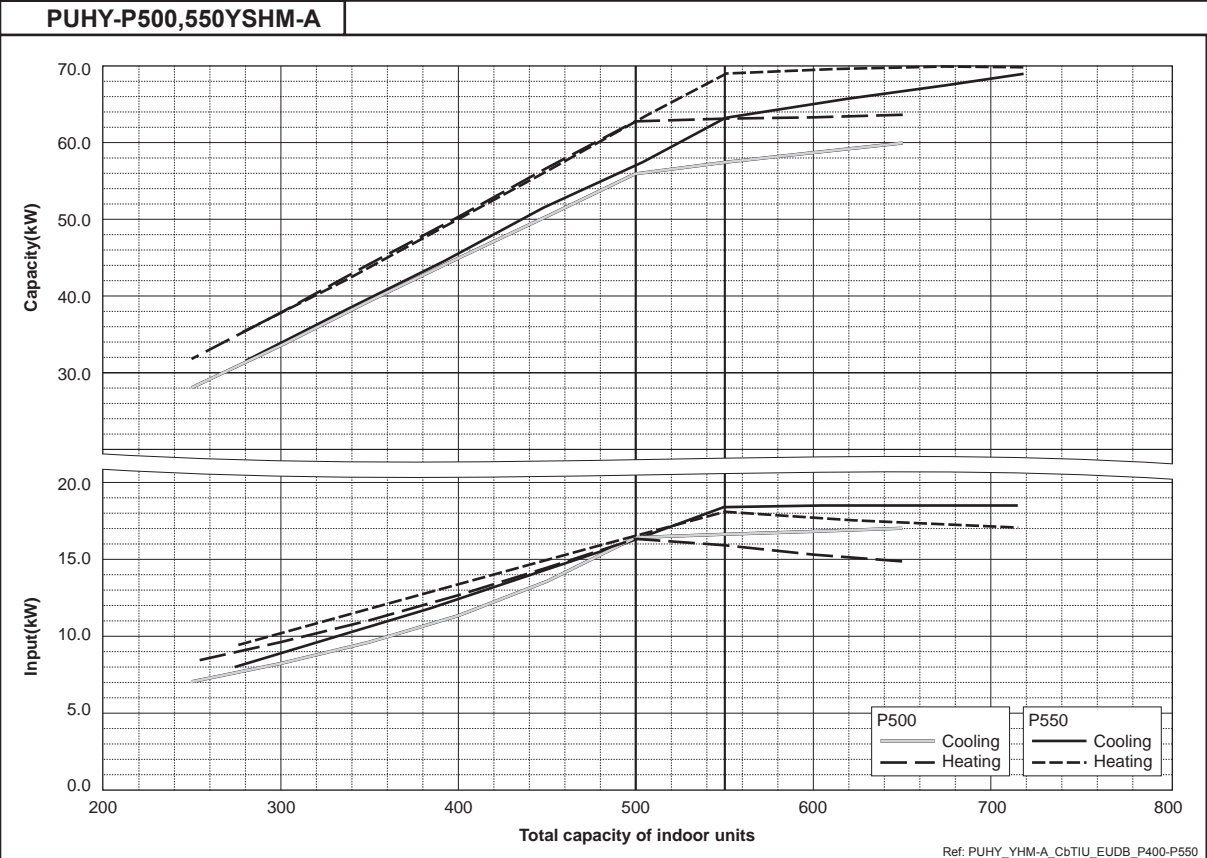
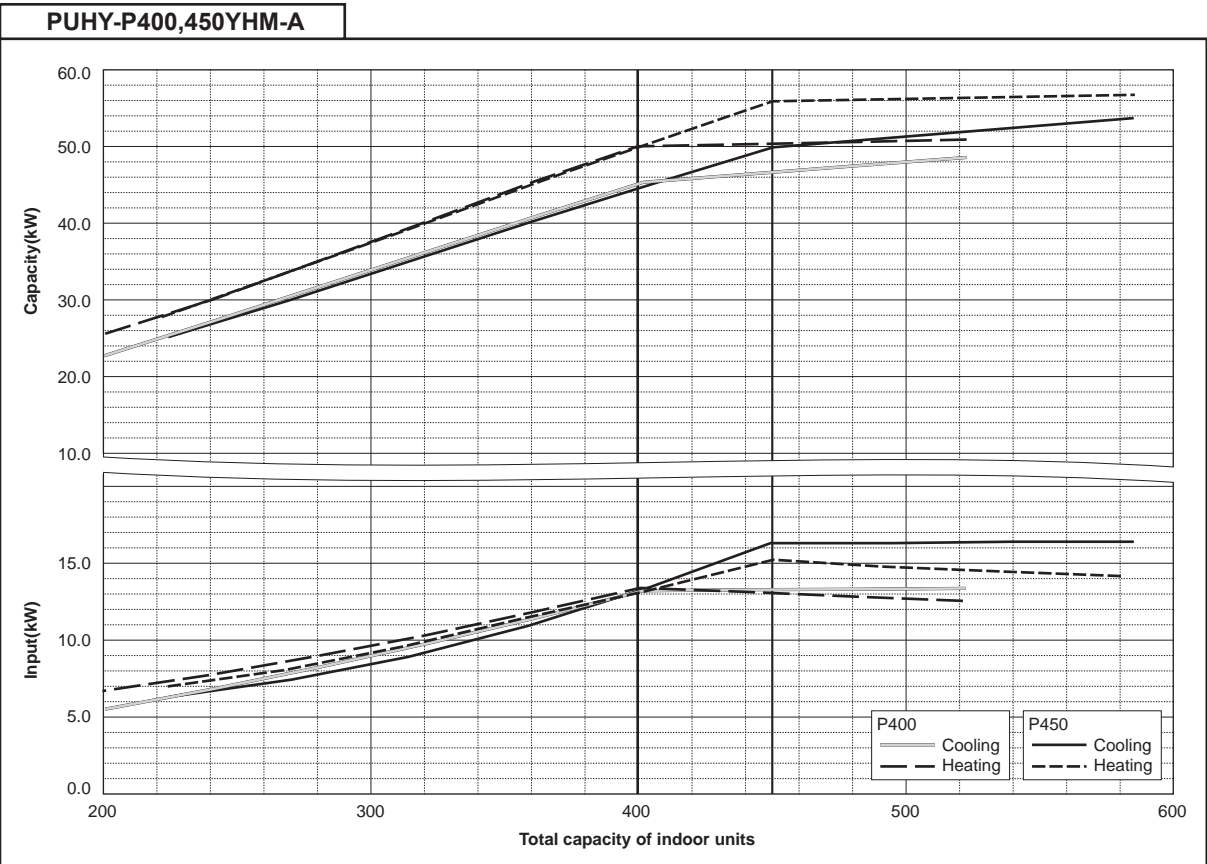

Ref: PUHY\_YHM-A\_CbTIU\_EUDB\_P400-P550

**PUHY-P600,650YSHM-A**

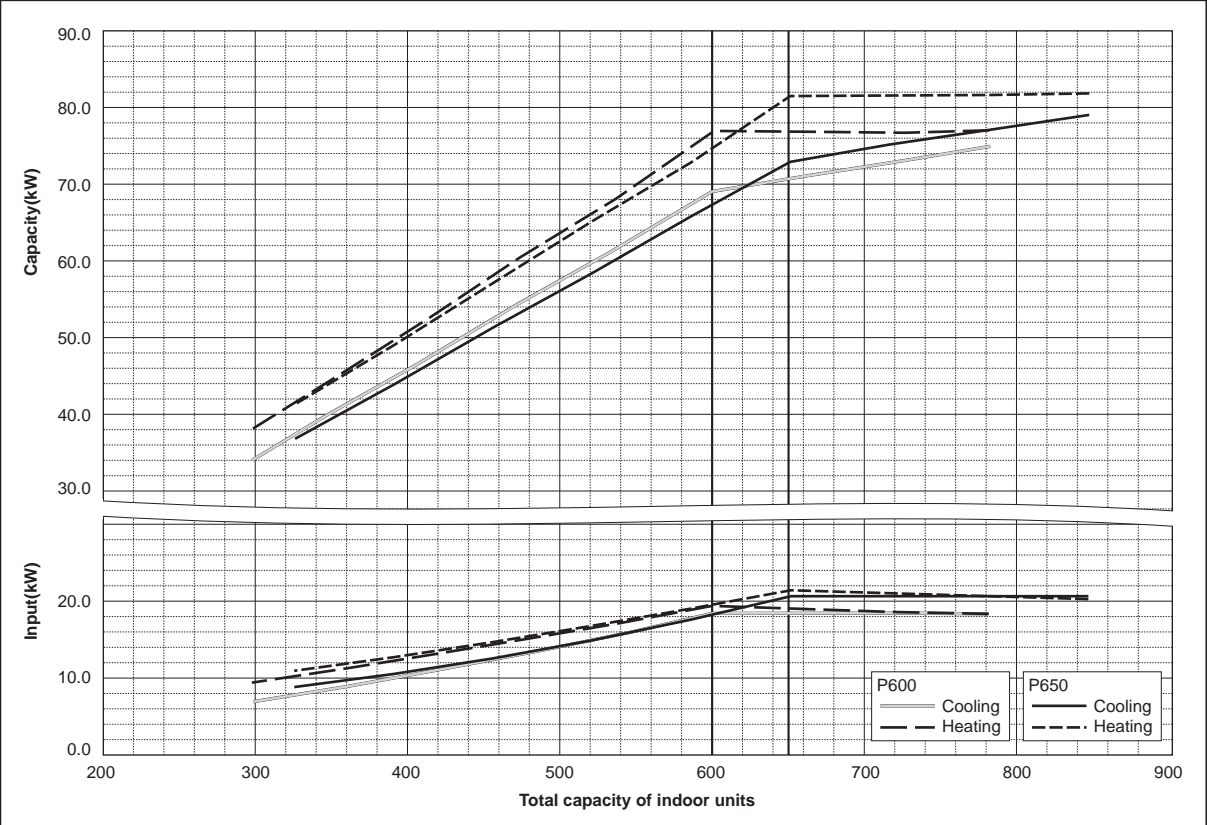

**PUHY-P700,750YSHM-A**

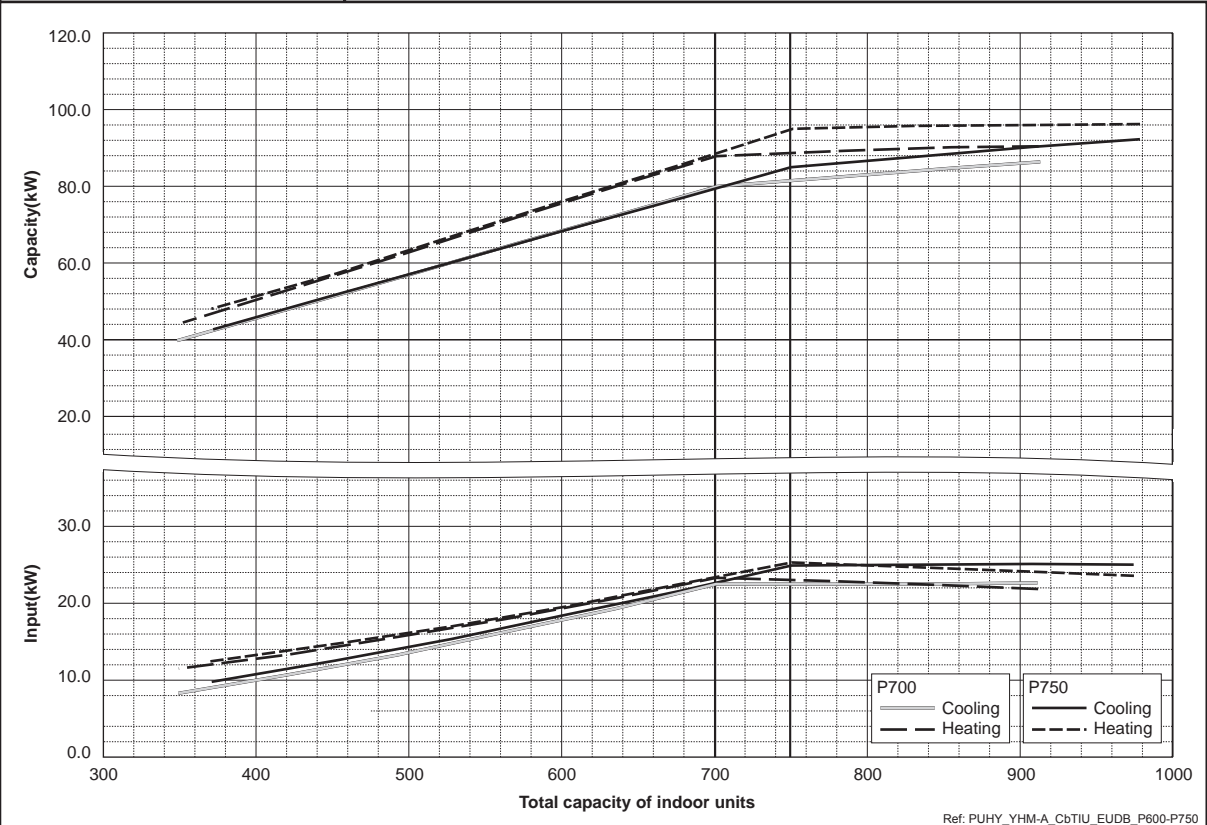

Ref: PUHY\_YHM-A\_CbTIU\_EUDB\_P600-P750

**PUHY-P800,850YSHM-A**

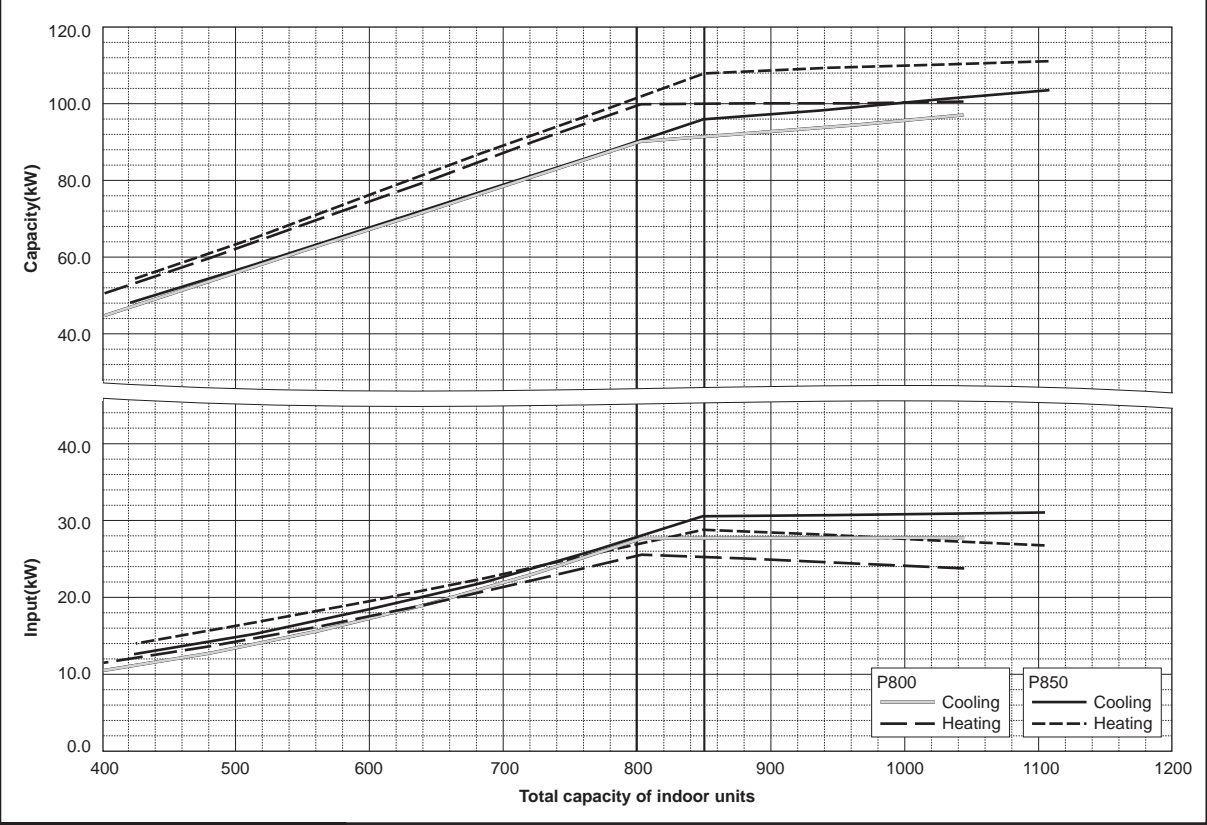

**PUHY-P900,950YSHM-A**

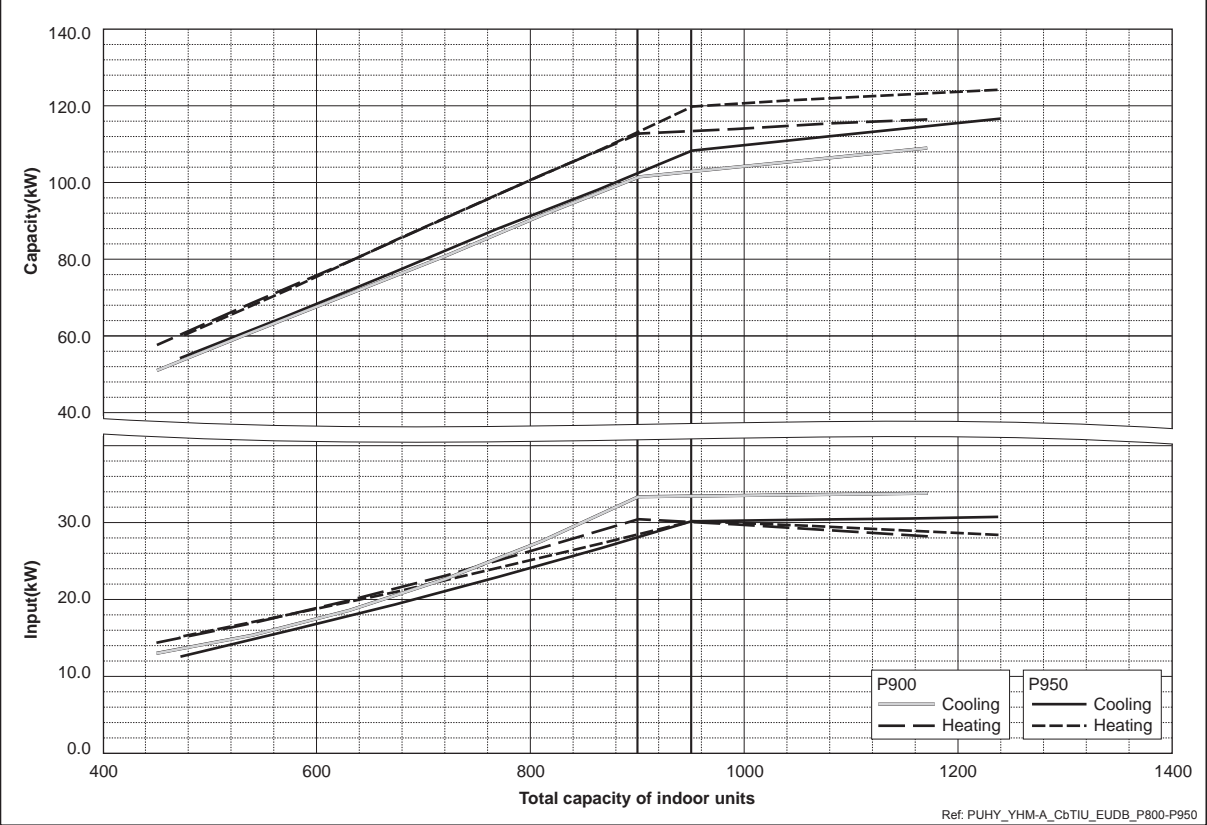

Ref: PUHY\_YHM-A\_CbTIU\_EUDB\_P800-P950

**PUHY-P1000,1050YSHM-A**

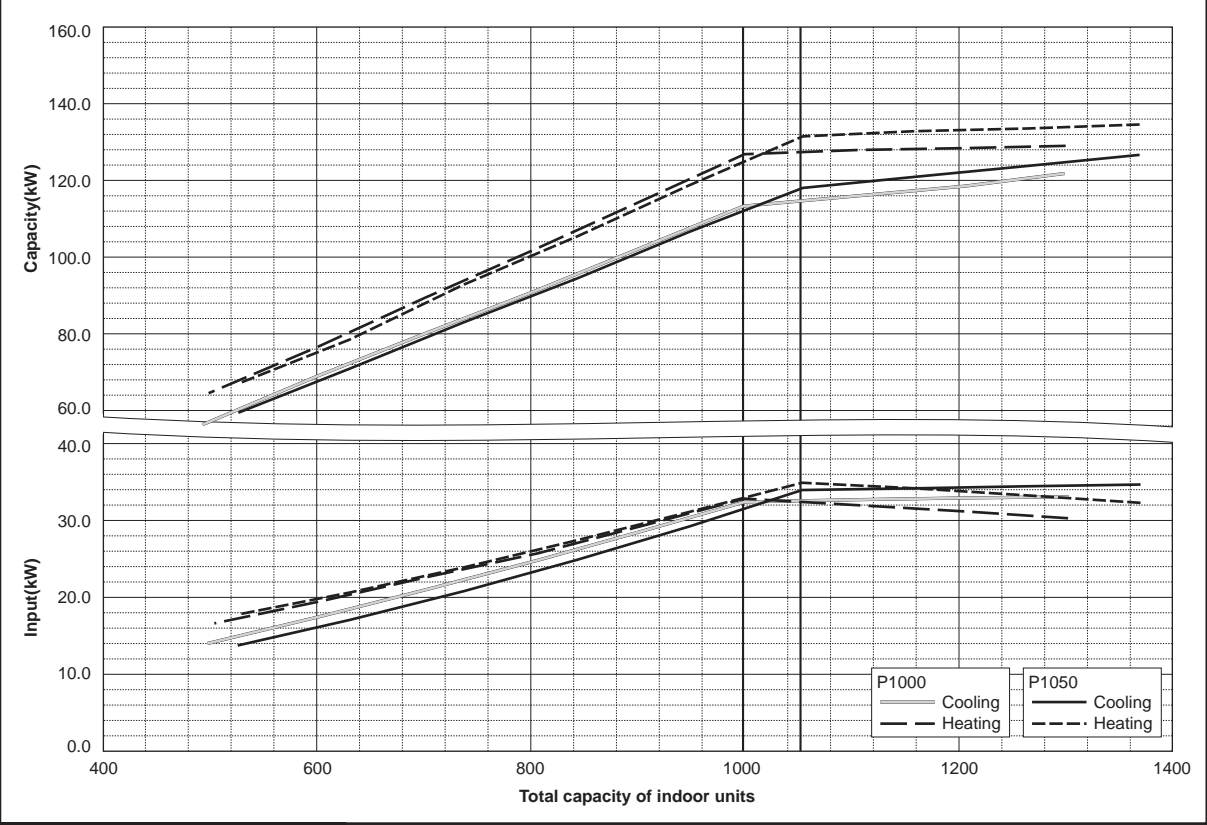

**PUHY-P1100,1150YSHM-A**

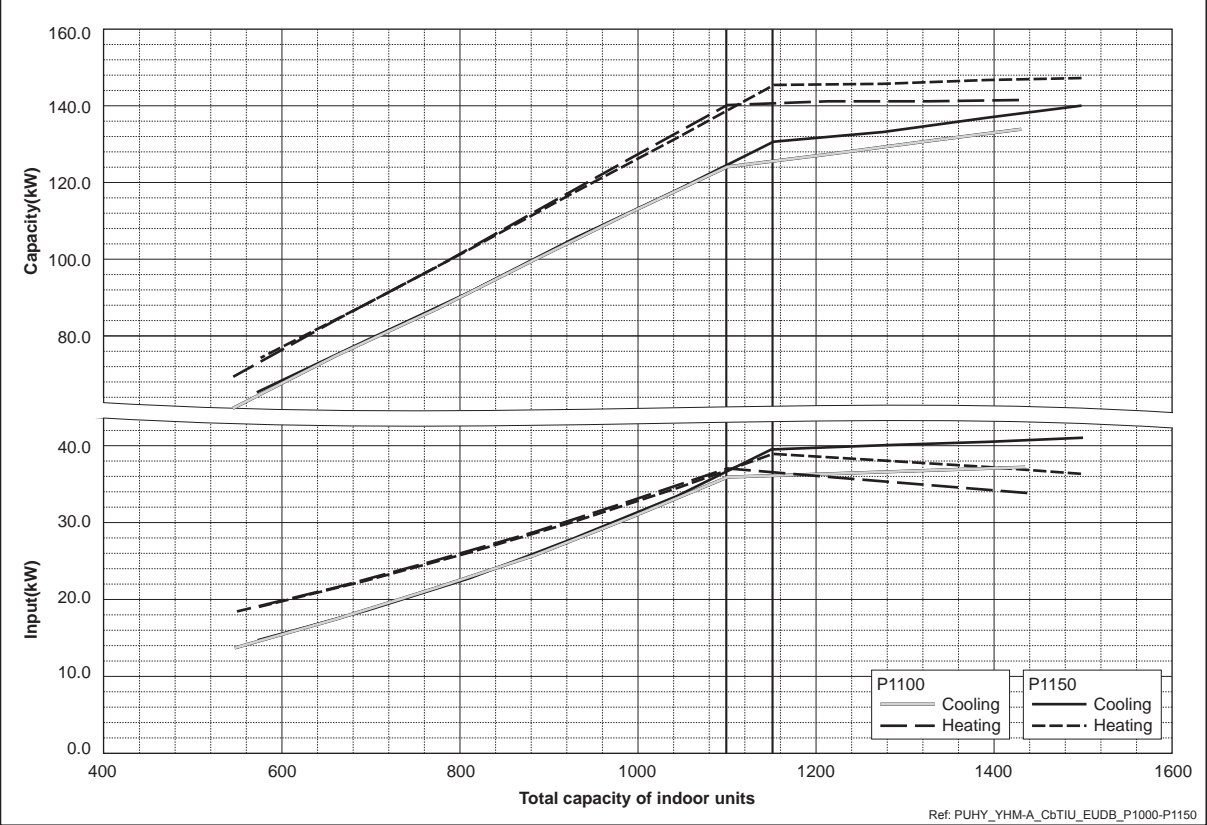

Ref. PUHY\_YHM-A\_CbTIU\_EUDB\_P1000-P1150



**PUHY-P1200,1250YSHM-A**

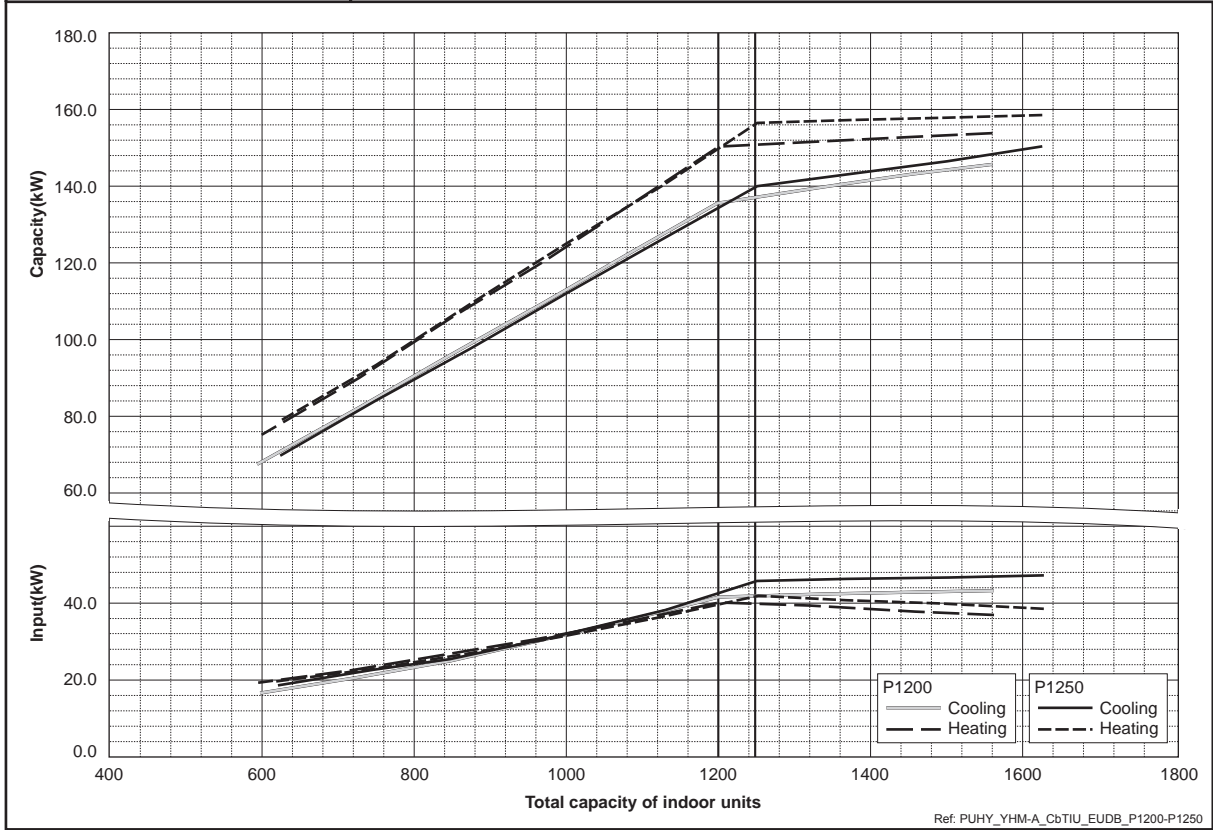

(1)-2 R2 series

**PURY-P200,250YHM-A(-BS)**

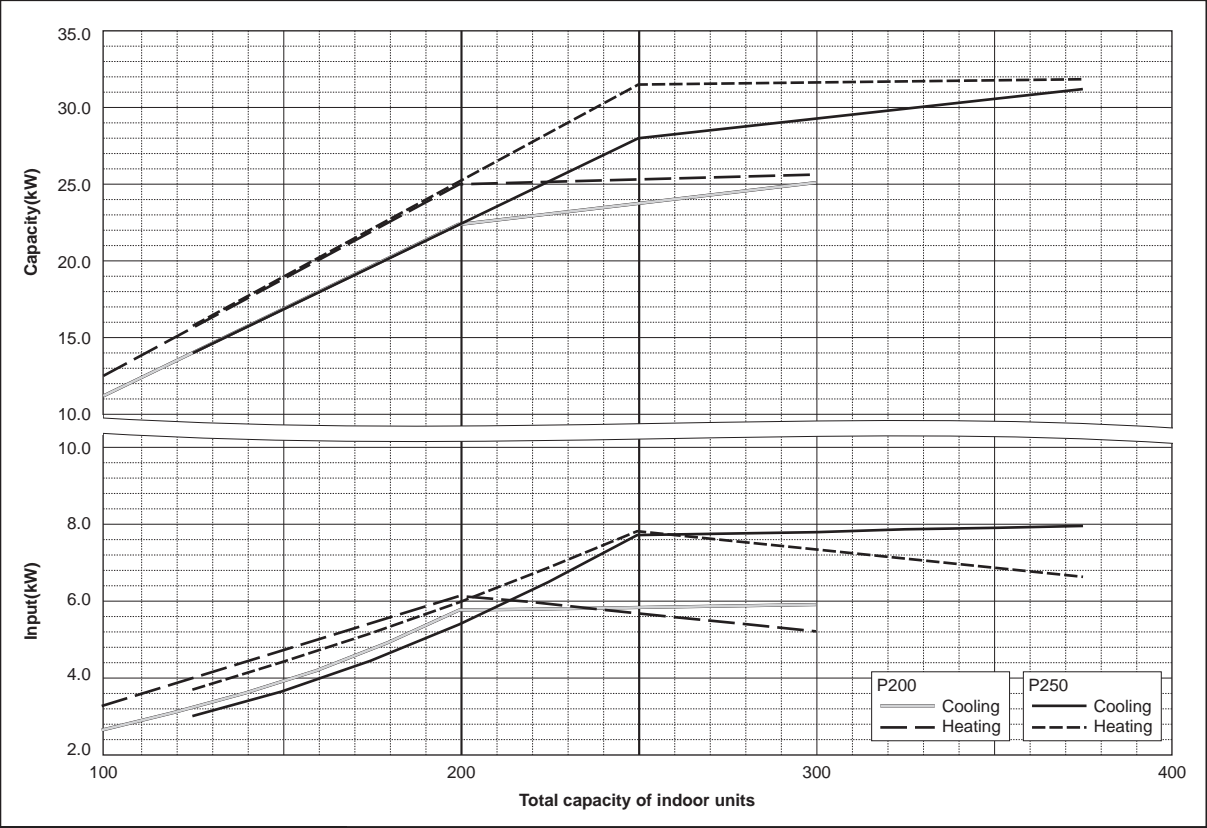

**PURY-P300,350YHM-A(-BS)**

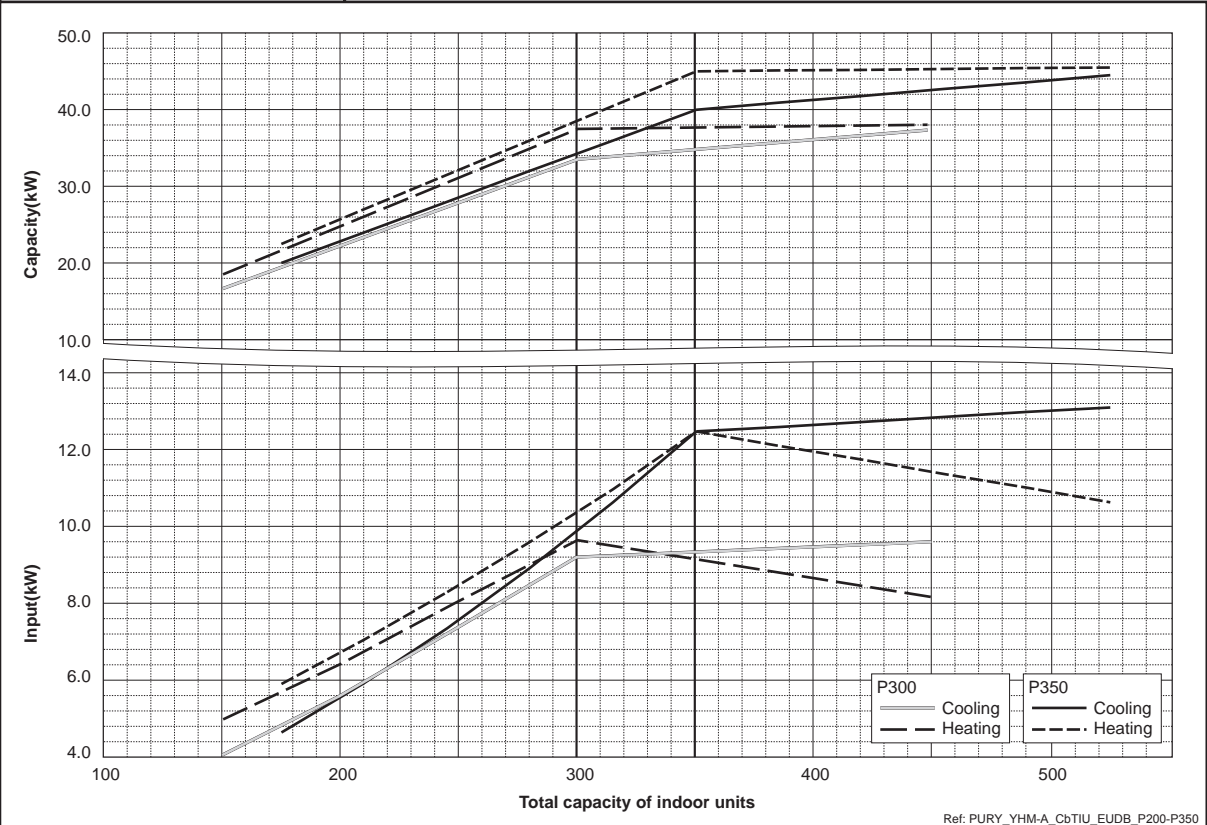

Ref: PURY\_YHM-A\_CbTIU\_EUDB\_P200-P350

**PURY-P400,450Y(S)HM-A(-BS)**

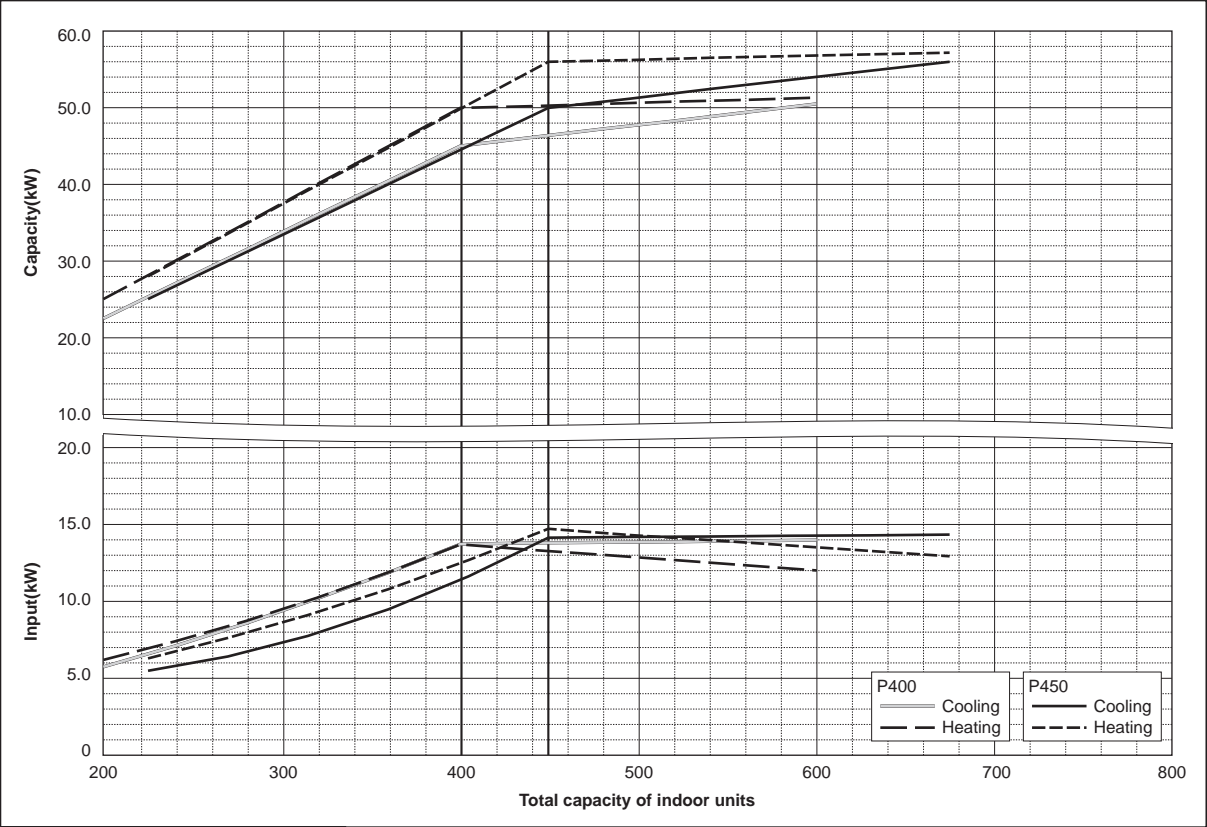

**PURY-P500,550YSHM-A(-BS)**

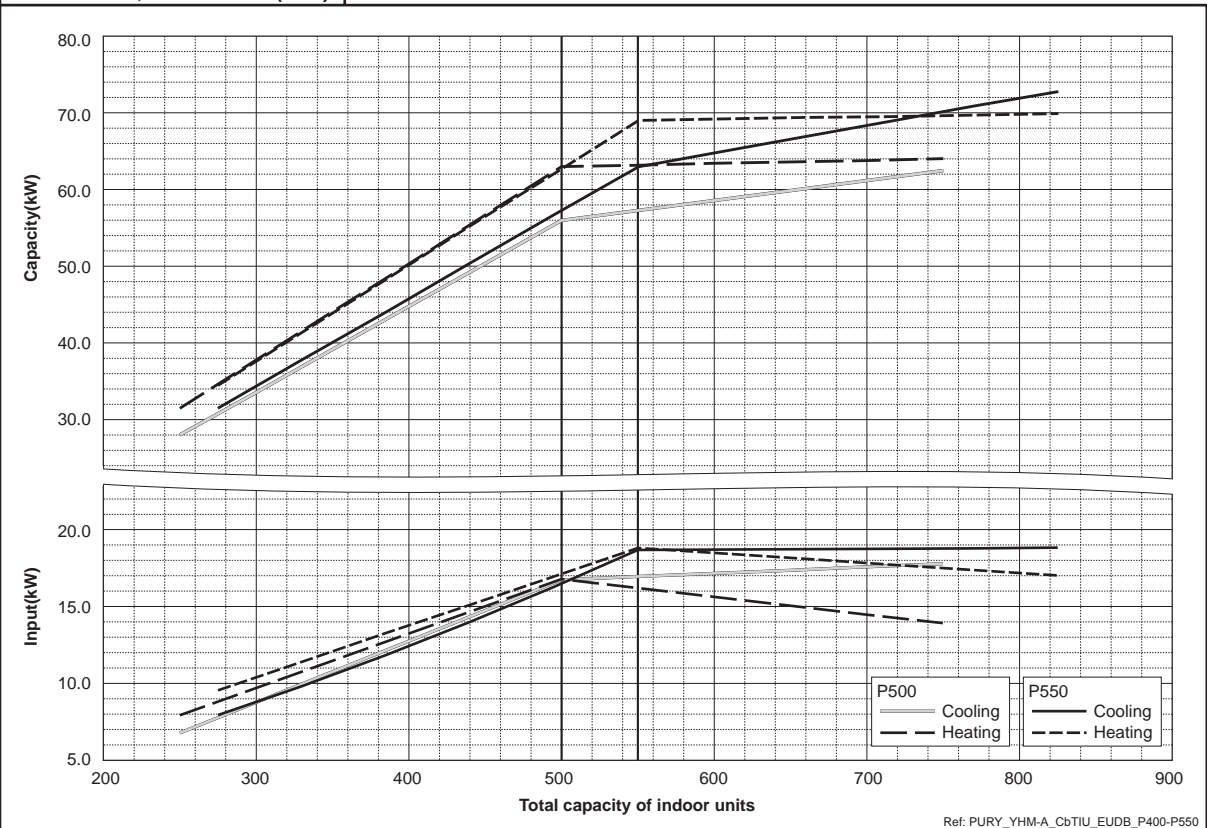

Ref: PURY\_YHM-A\_CbTIU\_EUDB\_P400-P550

**PURY-P600,650YSHM-A(-BS)**

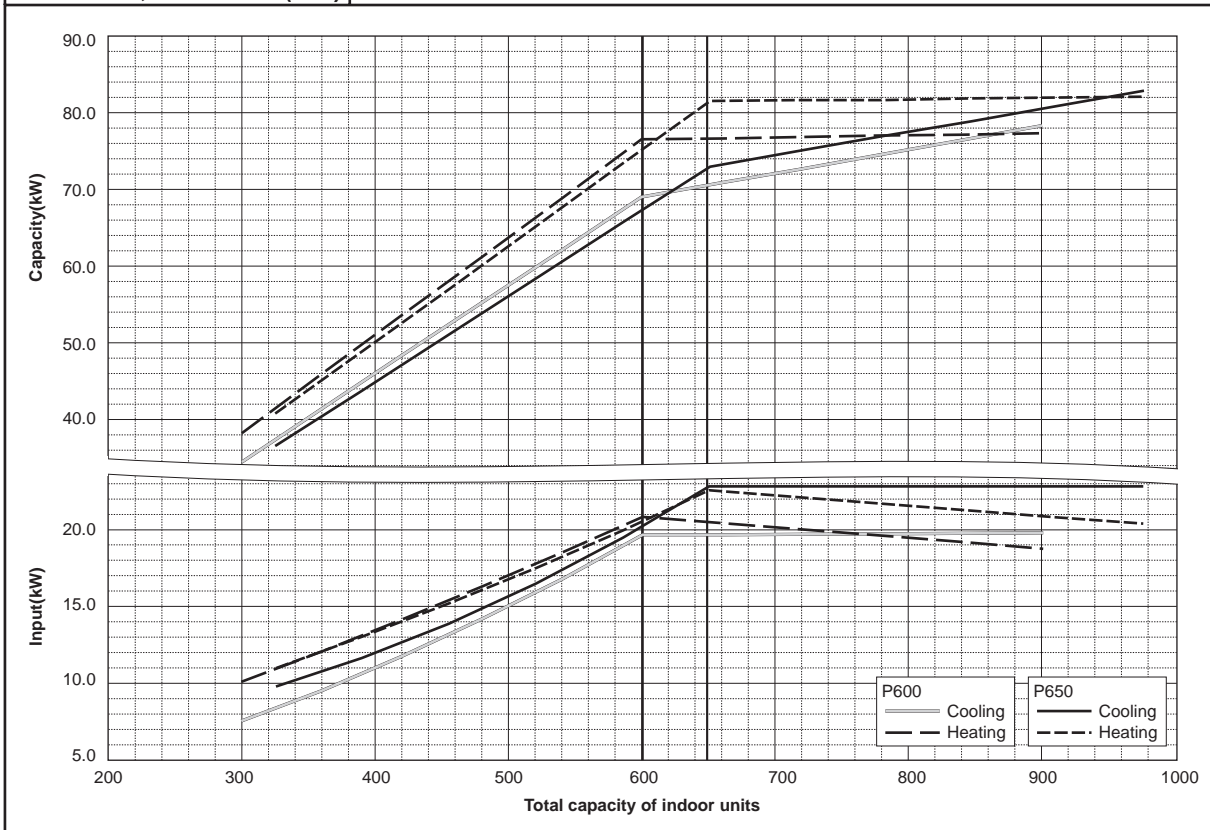

**PURY-P700,750YSHM-A(-BS)**

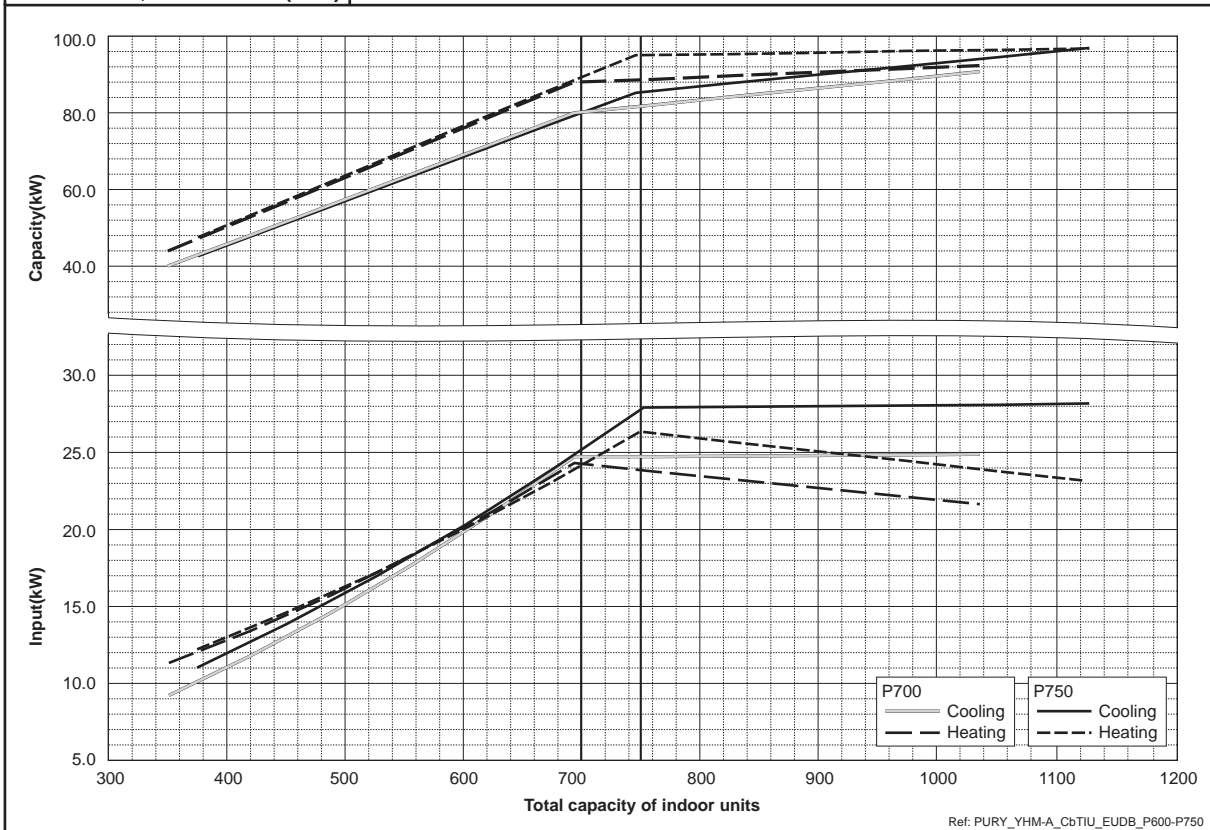

Ref: PURY\_YHM-A\_CbTIU\_EUDB\_P600-P750

**PURY-P800YSHM-A(-BS)**

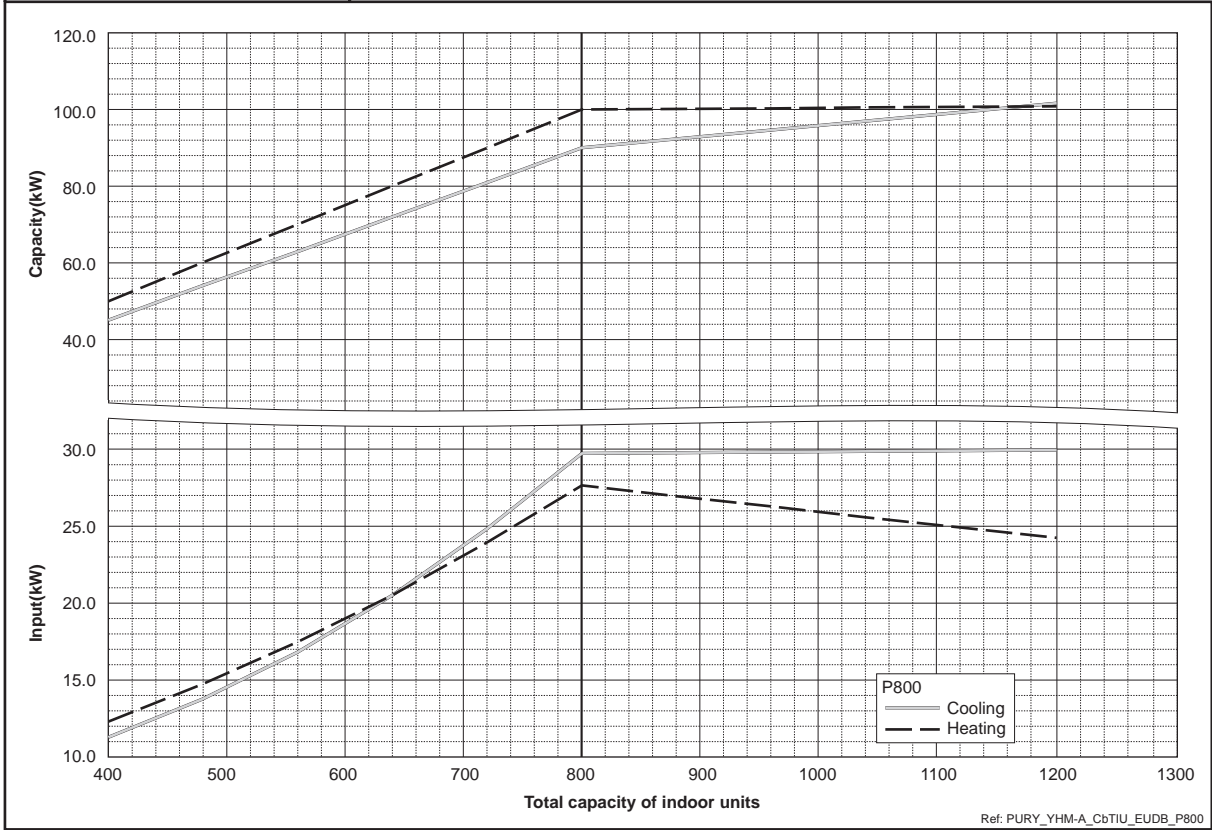

(2) Correction by refrigerant piping length

(2)-1 Y series

(2)-1-1 Cooling capacity correction

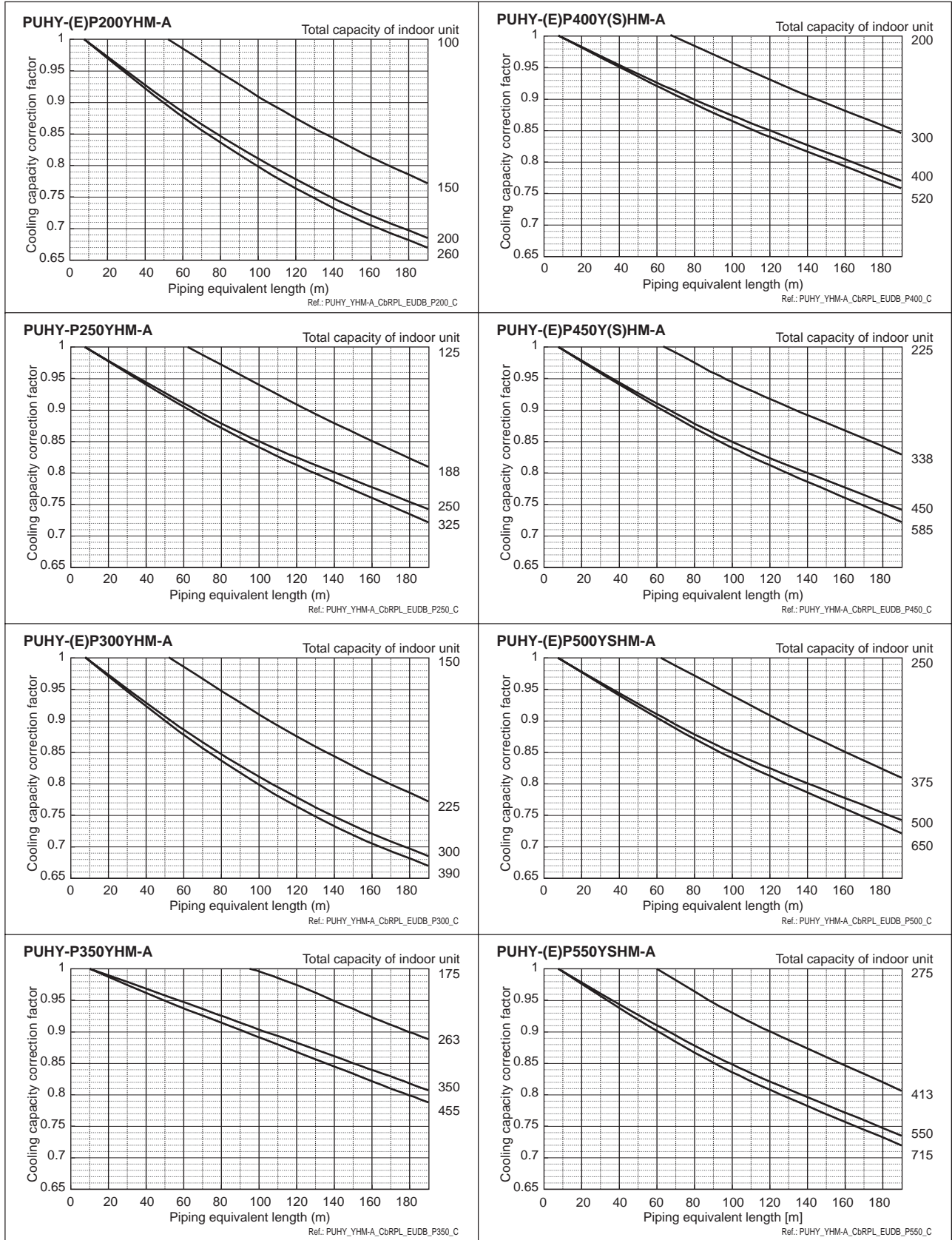

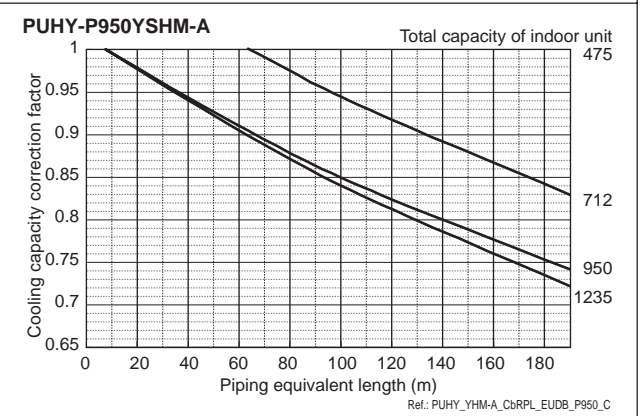
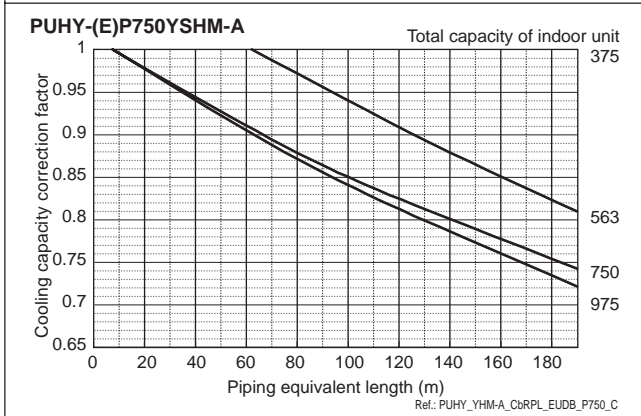
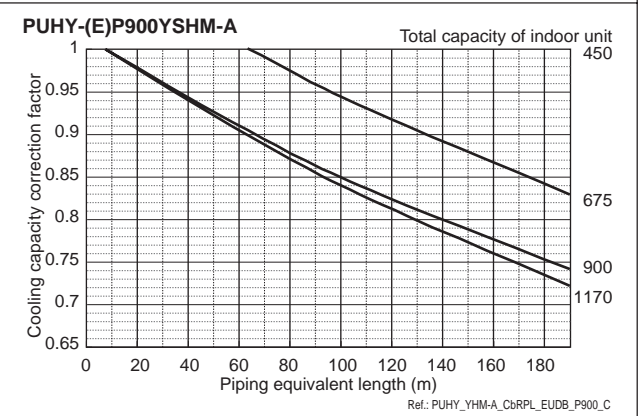
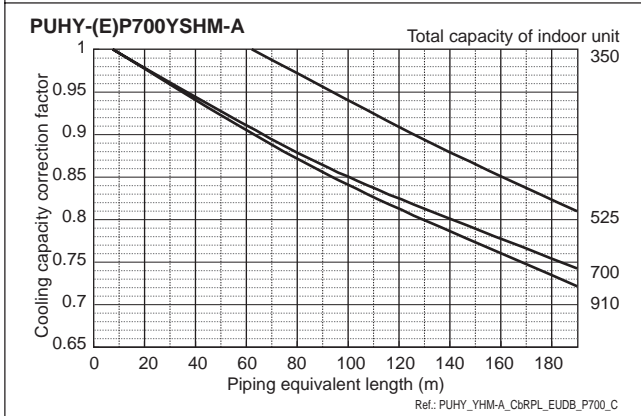
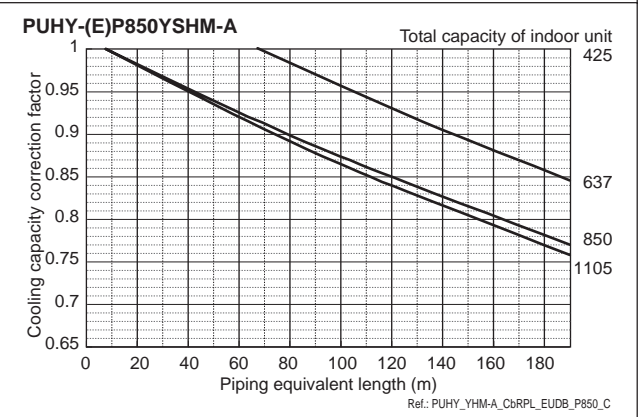
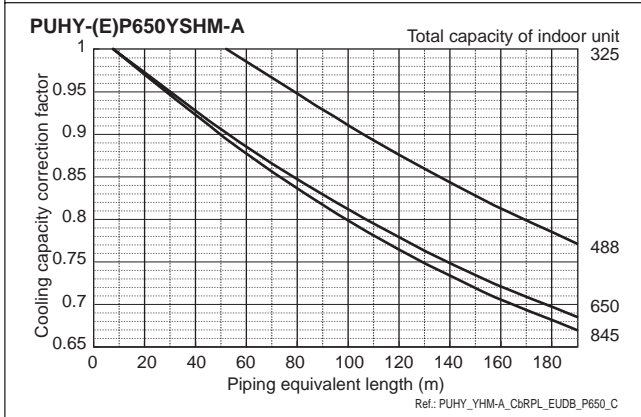
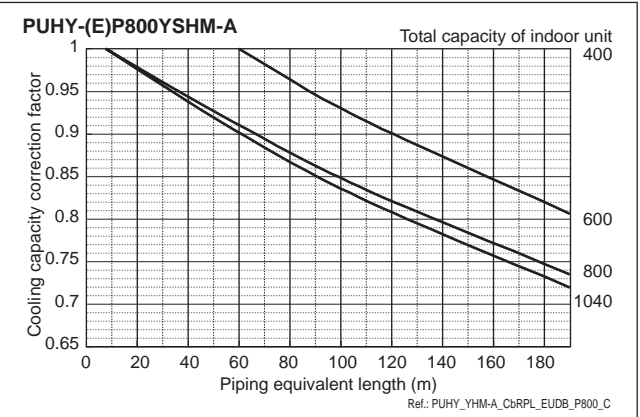
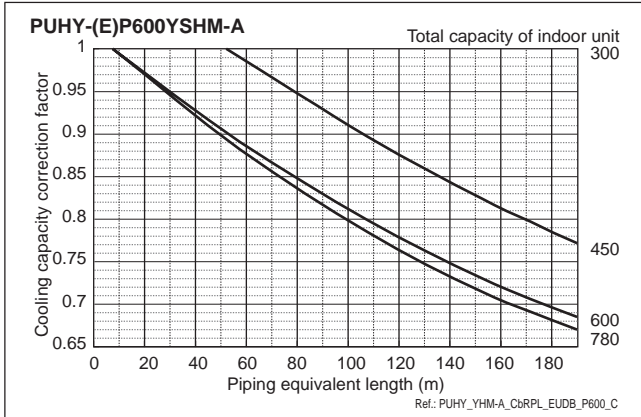

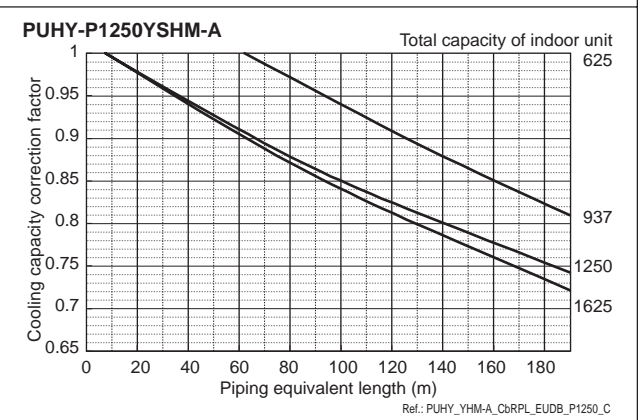
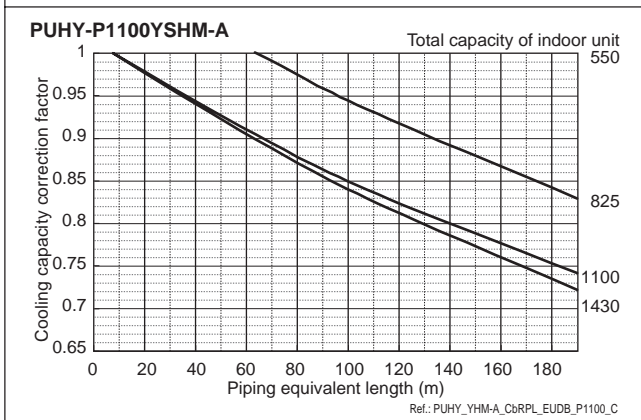
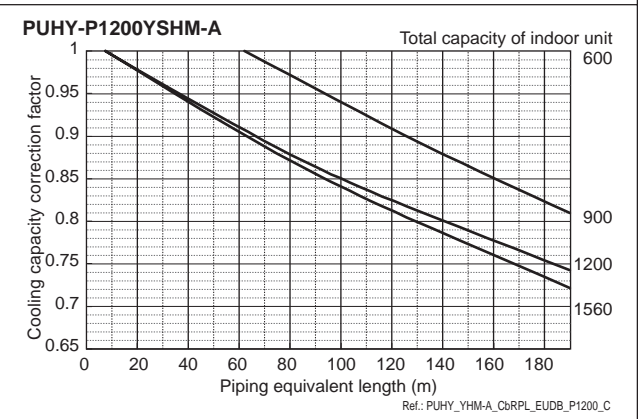
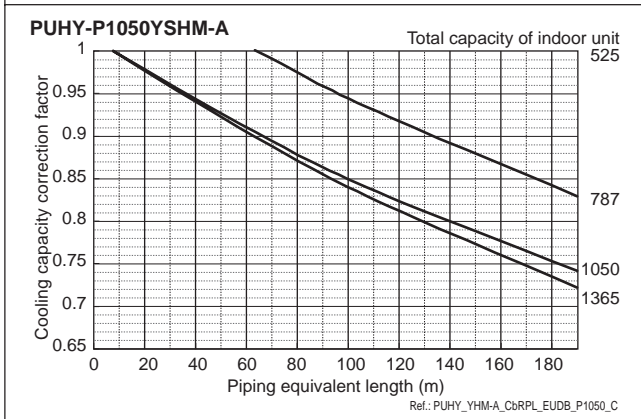
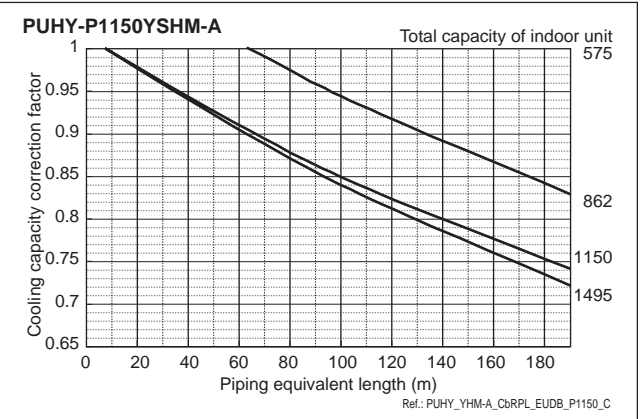
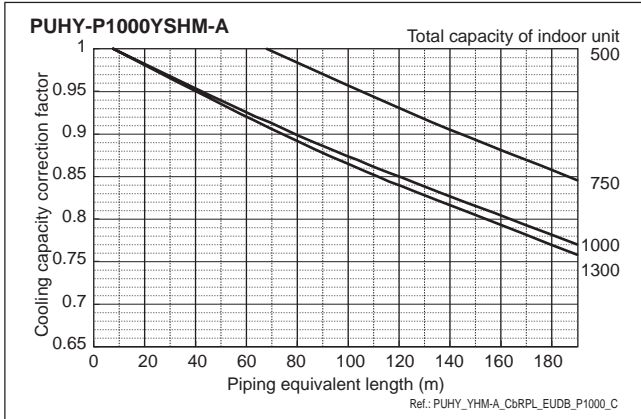



(2)-1-2 Heating capacity correction

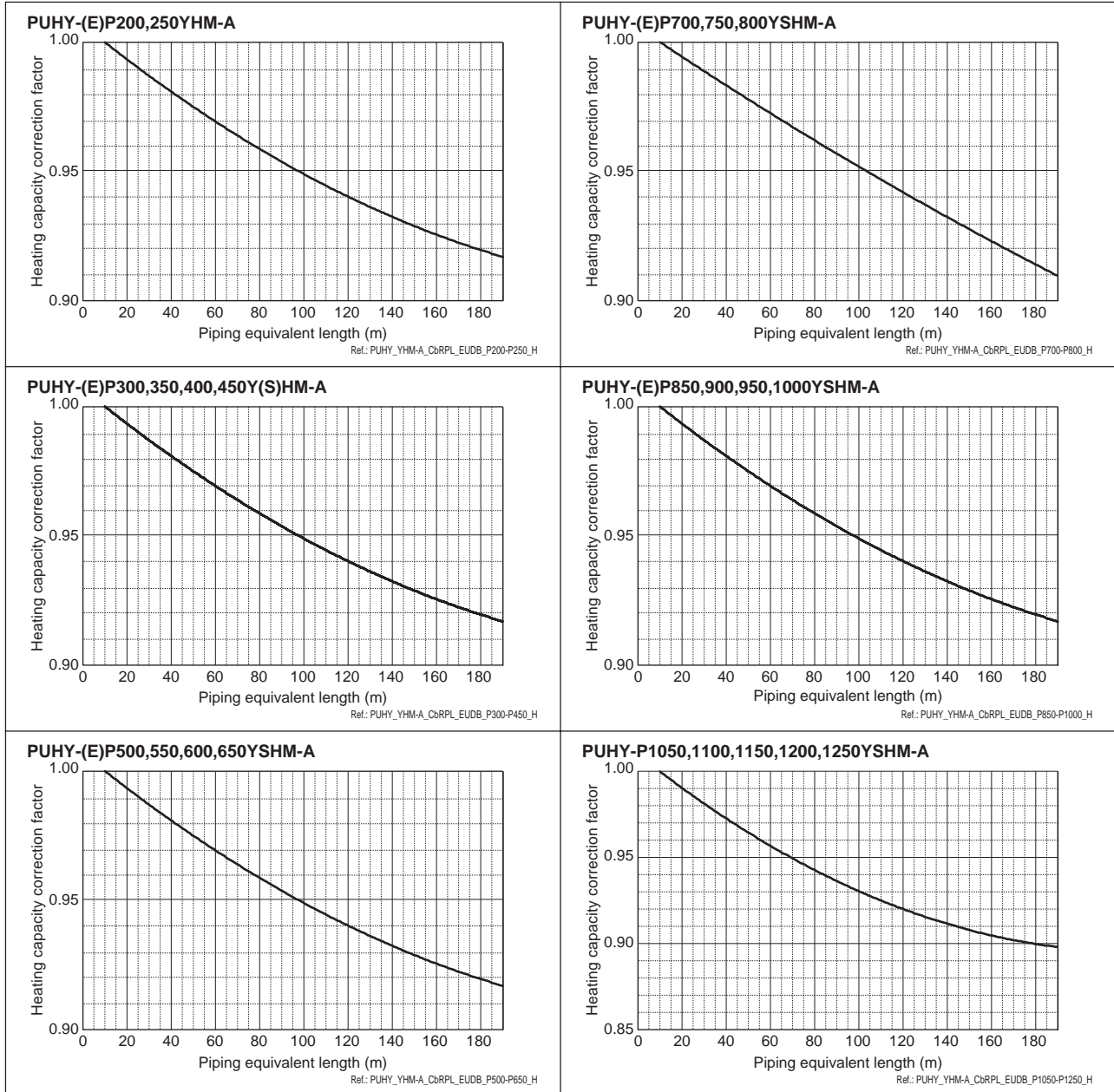

(2)-2 R2 series

(2)-2-1 Cooling capacity correction

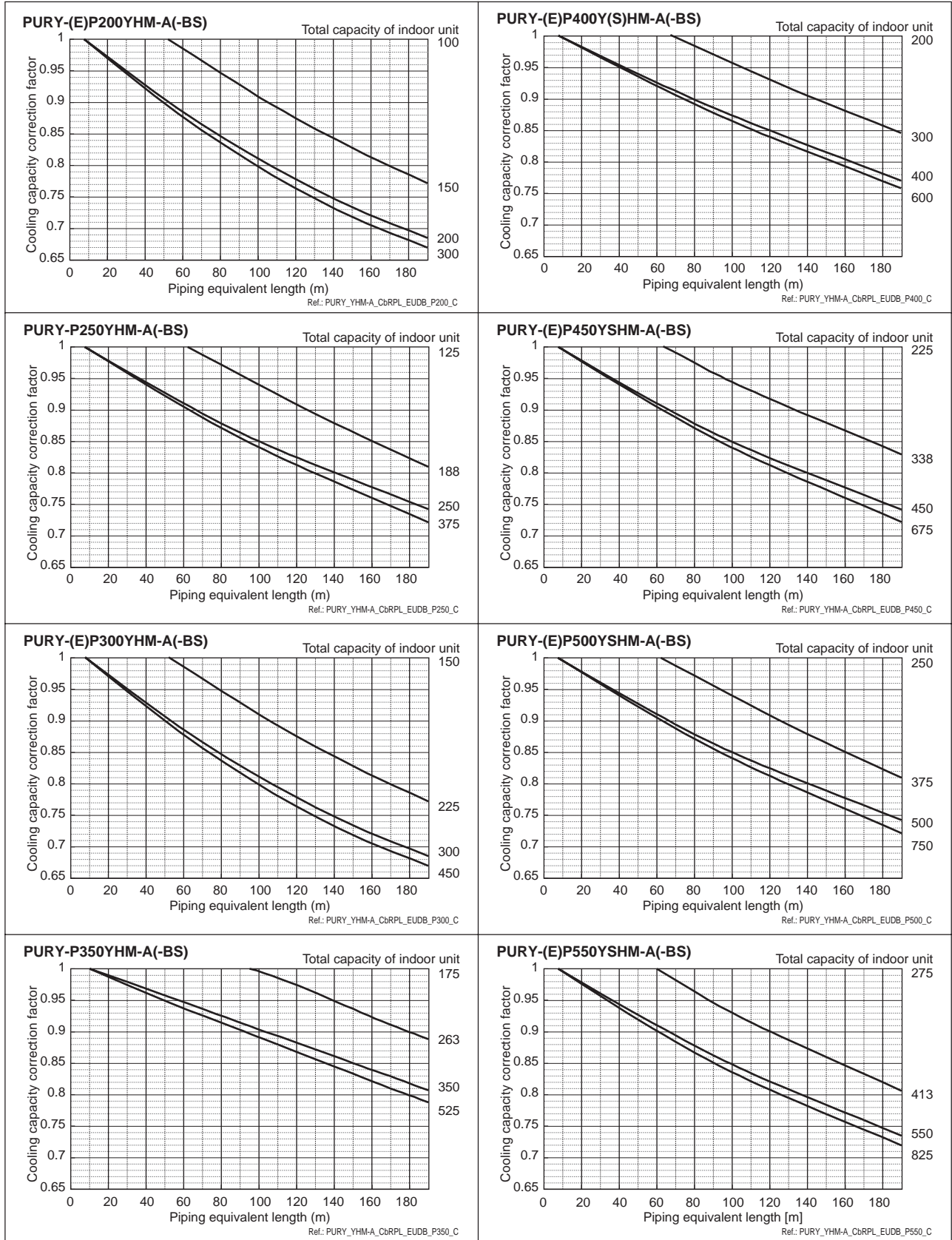

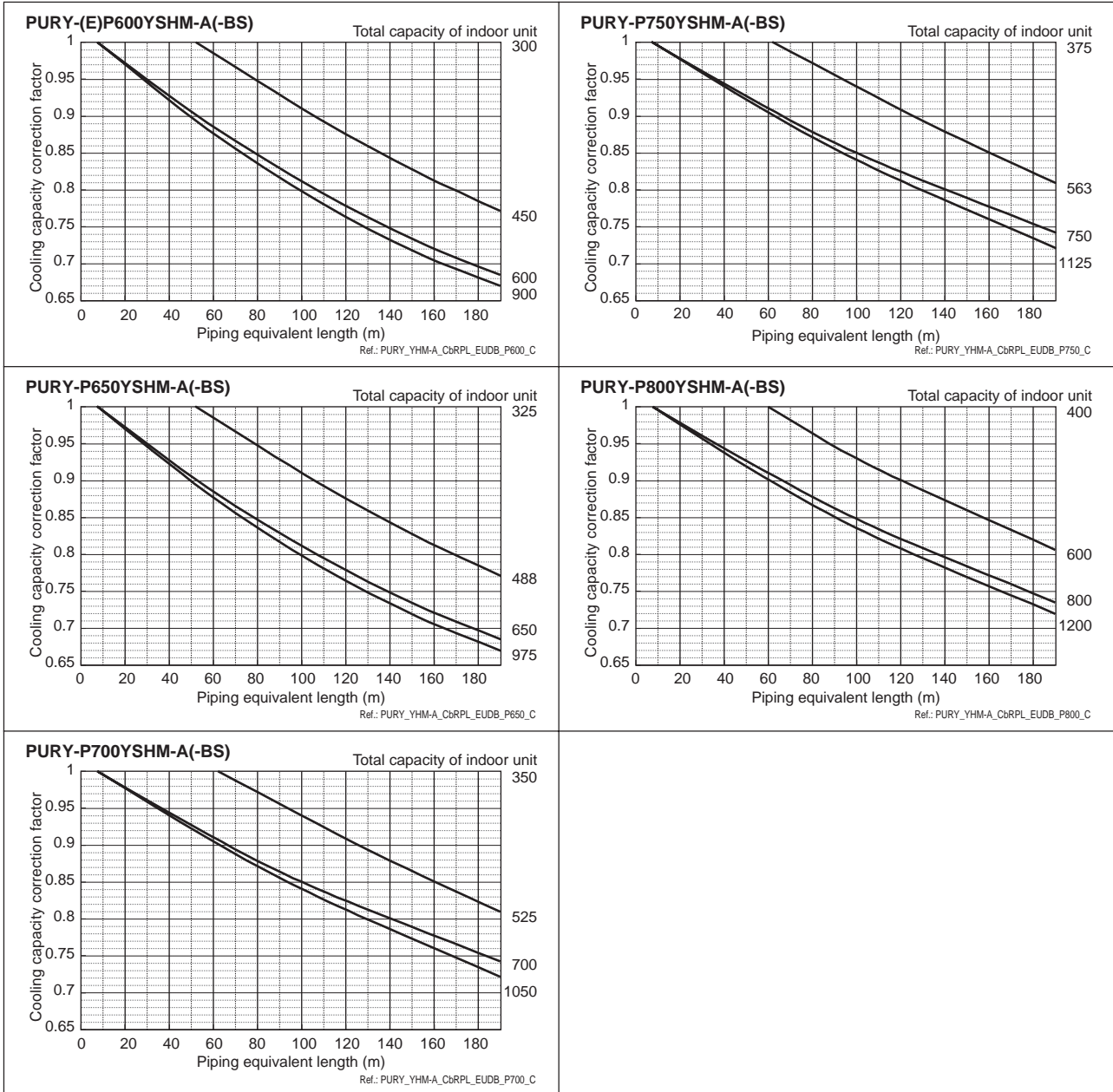

(2)-2-2 Heating capacity correction

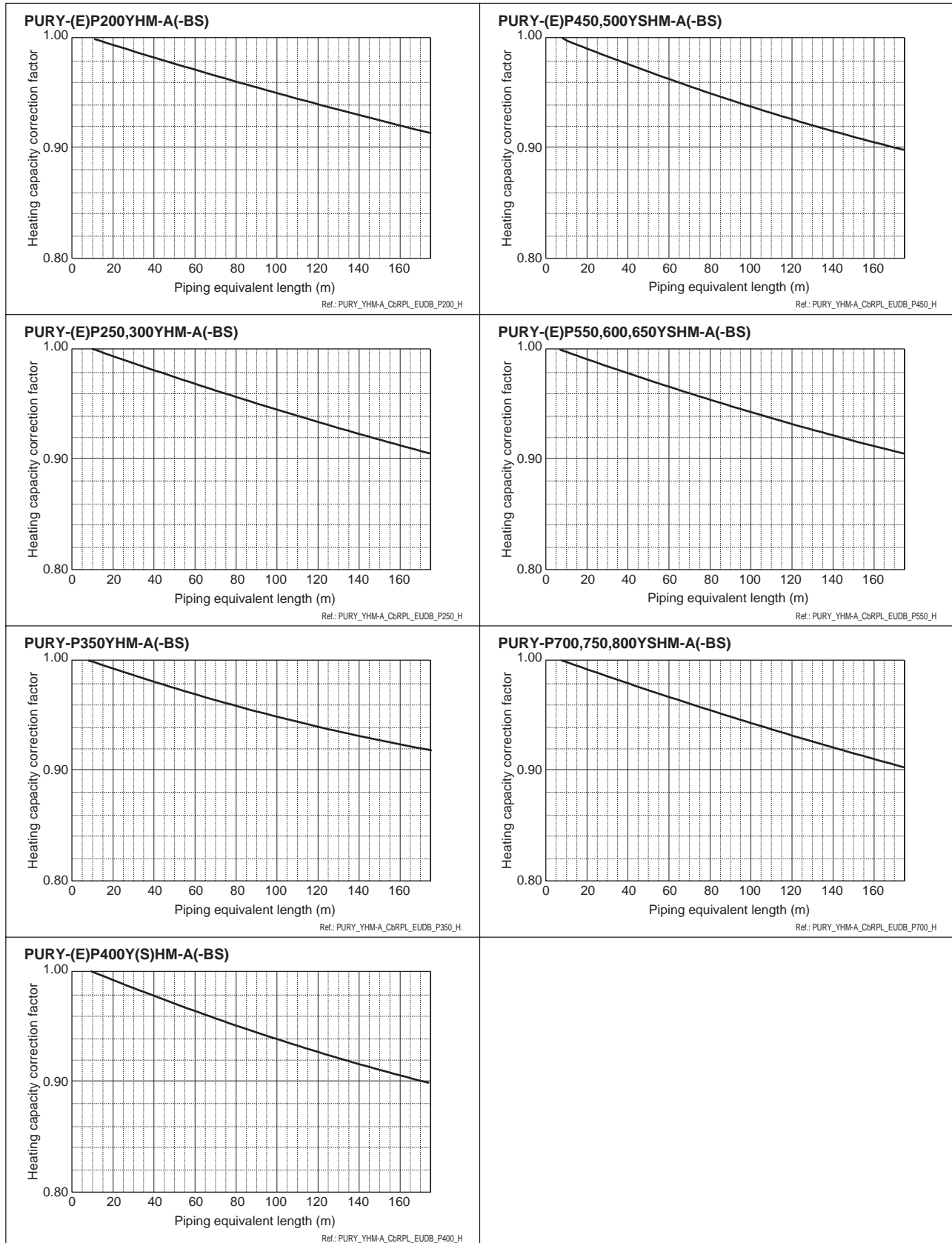

### (3) Correction at frosting and defrosting

Due to frosting at the outdoor heat exchanger and the automatic defrosting operation, the heating capacity of the outdoor unit should be considered by multiplying the correction factor which shown in the table below.

#### (3)-1 Y series

Table of correction factor at frosting and defrosting

Outdoor inlet air temp. °C	6	4	2	1	0	-2	-4	-6	-8	-10	-20
Outdoor inlet air temp. °F	43	39	36	34	32	28	25	21	18	14	-4
PUHY-(E)P200YHM	1.00	0.95	0.84	0.83	0.83	0.87	0.90	0.95	0.95	0.95	0.95
PUHY-P250YHM	1.00	0.95	0.84	0.83	0.83	0.87	0.90	0.95	0.95	0.95	0.95
PUHY-(E)P300YHM	1.00	0.93	0.82	0.80	0.82	0.86	0.90	0.90	0.95	0.95	0.95
PUHY-P350YHM	1.00	0.93	0.85	0.83	0.84	0.86	0.90	0.90	0.95	0.95	0.95
PUHY-(E)P400YHM	1.00	0.95	0.90	0.87	0.88	0.89	0.90	0.95	0.95	0.95	0.95
PUHY-(E)P450YHM	1.00	0.98	0.89	0.87	0.89	0.90	0.92	0.95	0.95	0.95	0.95
PUHY-(E)P500YSHM	1.00	0.98	0.89	0.86	0.89	0.90	0.92	0.95	0.95	0.95	0.95
PUHY-(E)P550YSHM	1.00	0.94	0.87	0.86	0.87	0.88	0.90	0.90	0.93	0.93	0.93
PUHY-(E)P600YSHM	1.00	0.94	0.84	0.86	0.87	0.88	0.90	0.90	0.93	0.93	0.93
PUHY-(E)P650YSHM	1.00	0.94	0.84	0.86	0.87	0.88	0.90	0.90	0.93	0.93	0.93
PUHY-(E)P700YSHM	1.00	0.98	0.89	0.88	0.89	0.90	0.92	0.95	0.95	0.95	0.95
PUHY-(E)P750YSHM	1.00	0.98	0.89	0.88	0.89	0.90	0.92	0.95	0.95	0.95	0.95
PUHY-(E)P800YSHM	1.00	0.98	0.89	0.88	0.89	0.90	0.92	0.95	0.95	0.95	0.95
PUHY-(E)P850YSHM	1.00	0.94	0.87	0.86	0.87	0.88	0.90	0.90	0.93	0.93	0.93
PUHY-(E)P900YSHM	1.00	0.94	0.87	0.86	0.87	0.88	0.90	0.90	0.93	0.93	0.93
PUHY-P950YSHM	1.00	0.94	0.87	0.86	0.87	0.88	0.90	0.90	0.93	0.93	0.93
PUHY-P1000YSHM	1.00	0.94	0.87	0.86	0.87	0.88	0.90	0.90	0.93	0.93	0.93
PUHY-P1050YSHM	1.00	0.94	0.87	0.86	0.87	0.88	0.90	0.90	0.93	0.93	0.93
PUHY-P1100YSHM	1.00	0.94	0.87	0.86	0.87	0.88	0.90	0.90	0.93	0.93	0.93
PUHY-P1150YSHM	1.00	0.94	0.87	0.86	0.87	0.88	0.90	0.90	0.93	0.93	0.93
PUHY-P1200YSHM	1.00	0.94	0.87	0.86	0.87	0.88	0.90	0.90	0.93	0.93	0.93
PUHY-P1250YSHM	1.00	0.94	0.87	0.86	0.87	0.88	0.90	0.90	0.93	0.93	0.93

Ref.: PUHY\_YHM-A\_CbFROST\_EUDB\_ALL

#### (3)-2 R2 series

Table of correction factor at frosting and defrosting

Outdoor inlet air temp. °C	6	4	2	1	0	-2	-4	-6	-8	-10	-20
Outdoor inlet air temp. °F	43	39	36	34	32	28	25	21	18	14	-4
PURY-(E)P200YHM-A(-BS)	1.00	0.95	0.84	0.83	0.83	0.87	0.90	0.95	0.95	0.95	0.95
PURY-P250YHM-A(-BS)	1.00	0.95	0.84	0.83	0.83	0.87	0.90	0.95	0.95	0.95	0.95
PURY-(E)P300YHM-A(-BS)	1.00	0.93	0.82	0.80	0.82	0.86	0.90	0.90	0.95	0.95	0.95
PURY-P350YHM-A(-BS)	1.00	0.93	0.85	0.83	0.84	0.86	0.90	0.90	0.95	0.95	0.95
PURY-(E)P400Y(S)HM-A(-BS)	1.00	0.95	0.90	0.87	0.88	0.89	0.90	0.95	0.95	0.95	0.95
PURY-(E)P450YSHM-A(-BS)	1.00	0.98	0.89	0.87	0.89	0.90	0.92	0.95	0.95	0.95	0.95
PURY-(E)P500YSHM-A(-BS)	1.00	0.98	0.89	0.86	0.89	0.90	0.92	0.95	0.95	0.95	0.95
PURY-(E)P550YSHM-A(-BS)	1.00	0.94	0.87	0.86	0.87	0.88	0.90	0.90	0.93	0.93	0.93
PURY-(E)P600YSHM-A(-BS)	1.00	0.94	0.84	0.86	0.87	0.88	0.90	0.90	0.93	0.93	0.93
PURY-P650YSHM-A(-BS)	1.00	0.94	0.84	0.86	0.87	0.88	0.90	0.90	0.93	0.93	0.93
PURY-P700YSHM-A(-BS)	1.00	0.98	0.89	0.88	0.89	0.90	0.92	0.95	0.95	0.95	0.95
PURY-P750YSHM-A(-BS)	1.00	0.98	0.89	0.88	0.89	0.90	0.92	0.95	0.95	0.95	0.95
PURY-P800YSHM-A(-BS)	1.00	0.98	0.89	0.88	0.89	0.90	0.92	0.95	0.95	0.95	0.95

Ref.: PURY\_YHM-A\_CbFROST\_EUDB\_ALL

**DATA BOOK**    **PWFY-P100VM-E-BU**  
**PWFY-P100VM-E-AU**  
**PWFY-P200VM-E-AU**

